

USER MANUAL

ProLite

LCD Monitor

ENGLISH

ProLite TH4265MIS
ProLite LH4265S

Thank you very much for choosing the iiyama LCD monitor.

We recommend that you take a few minutes to read this comprehensive manual carefully before installing and switching on the monitor. Please keep this manual in a safe place for your future reference.

CE MARKING DECLARATION OF CONFORMITY

This LCD monitor complies with the requirements of the EC/EU Directive 2014/30/EU "EMC Directive", 2014/35/EU "Low Voltage Directive" and 2011/65/EU "RoHS Directive".

Warning

This is a class A product. In a domestic environment this product may cause radio interference in which case the user may be required to take adequate measures.

IYAMA CORPORATION: Wijkmeerstraat 8, 2131 HA Hoofddorp, The Netherlands

Model No. : PL4265



We recommend recycling of used product. Please contact your dealer or iiyama service center. Recycle information is obtained via the Internet, using the address: <http://www.iiyama.com>

You can access the Web page of different countries from there.

- We reserve the right to change specifications without notice.
- All trademarks used in this user manual are the property of their respective owners.

TABLE OF CONTENTS

FOR YOUR SAFETY.....	1
SAFETY PRECAUTIONS.....	1
SPECIAL NOTES ON LCD MONITORS	3
CUSTOMER SERVICE	5
CLEANING	5
BEFORE YOU OPERATE THE MONITOR.....	6
FEATURES.....	6
CHECKING THE CONTENTS OF THE PACKAGE	6
UNPACKING	7
SPECIAL NOTES ON : ProLite TH4265MIS	7
CONTROLS AND CONNECTORS : MONITOR.....	8
INSTALLATION	11
CONTROLS AND CONNECTORS : REMOTE CONTROL.....	13
PREPARING THE REMOTE CONTROL.....	14
BASIC OPERATION.....	15
CONNECTING YOUR MONITOR.....	18
COMPUTER SETTING	22
OPERATING THE MONITOR.....	24
ADJUSTMENT MENU CONTENTS.....	26
SCREEN ADJUSTMENTS	37
POWER MANAGEMENT FEATURE.....	40
TROUBLE SHOOTING	41
RECYCLING INFORMATION.....	42
APPENDIX	43
SPECIFICATIONS : ProLite TH4265MIS	43
SPECIFICATIONS : ProLite LH4265S	45
DIMENSIONS : ProLite TH4265MIS	46
DIMENSIONS : ProLite LH4265S	46
COMPLIANT TIMING	47

FOR YOUR SAFETY

SAFETY PRECAUTIONS

WARNING

STOP OPERATING THE MONITOR WHEN YOU SENSE TROUBLE

If you notice any abnormal phenomena such as smoke, strange sounds or fumes, unplug the monitor and contact your dealer or iiyama service center immediately. Further use may be dangerous and can cause fire or electric shock.

NEVER REMOVE THE CABINET

High voltage circuits are inside the monitor. Removing the cabinet may expose you to the danger of fire or electric shock.

DO NOT PUT ANY OBJECT INTO THE MONITOR

Do not put any solid objects or liquids such as water into the monitor. In case of an accident, unplug your monitor immediately and contact your dealer or iiyama service center. Using the monitor with any object inside may cause fire, electric shock or damage.

INSTALL THE MONITOR ON A FLAT, STABLE SURFACE

The monitor may cause an injury if it falls or is dropped.

DO NOT USE THE MONITOR NEAR WATER

Do not use where water may be splashed or spilt onto the monitor as it may cause fire or electric shock.

OPERATE UNDER THE SPECIFIED POWER SUPPLY

Be sure to operate the monitor only with the specified power supply. Use of an incorrect voltage will cause malfunction and may cause fire or electric shock.

PROTECT THE CABLES

Do not pull or bend the power cable and signal cable. Do not place the monitor or any other heavy objects on the cables. If damaged, the cables may cause fire or electric shock.

ADVERSE WEATHER CONDITIONS

It is advisable not to operate the monitor during a heavy thunder storm as the continual breaks in power may cause malfunction. It is also advised not to touch the plug in these circumstances as it may cause electric shock.

CAUTION

INSTALLATION LOCATION

Do not install the monitor where sudden temperature changes may occur, or in humid, dusty or smoky areas as it may cause fire, electric shock or damage. You should also avoid areas where the sun shines directly on the monitor.

DO NOT PLACE THE MONITOR IN A HAZARDOUS POSITION

The monitor may topple and cause injury if not suitably located. Please also ensure that you do not place any heavy objects on the monitor, and that all cables are routed such that children may not pull the cables and possibly cause injury.

MAINTAIN GOOD VENTILATION

Ventilation slots are provided to keep the monitor from overheating. Covering the slots may cause fire. To allow adequate air circulation, place the monitor at least 10 cm (or 4 inches) from any walls. Operating the monitor on its back, side, upside down or on a carpet or any other soft material may also cause damage.

DISCONNECT THE CABLES WHEN YOU MOVE THE MONITOR

When you move the monitor, turn off the power switch, unplug the monitor and be sure the signal cable is disconnected. If you do not disconnect them, it may cause fire or electric shock.

UNPLUG THE MONITOR

If the monitor is not in use for a long period of time it is recommended that it is left unplugged to avoid accidents.

HOLD THE PLUG WHEN DISCONNECTING

To disconnect the power cable or signal cable, always pull it by the plug. Never pull on the cable itself as this may cause fire or electric shock.

DO NOT TOUCH THE PLUG WITH WET HANDS

Pulling or inserting the plug with wet hands may cause electric shock.

WHEN YOU INSTALL THE MONITOR ON YOUR COMPUTER

Be sure the computer is strong enough to hold the weight of the monitor, otherwise, you may damage your computer.

REMARK FOR 24/7 USAGE

This product is not specifically designed for 24/7 usage. (Recommended operating time is 18 hours/Day.)

OTHERS

ERGONOMIC RECOMMENDATIONS

To eliminate eye fatigue, do not operate the monitor against a bright background or in a dark room. For optimal viewing comfort, the monitor should be just below eye level and 40-60 cm (16-24 inches) away from your eyes. When using the monitor over a prolonged time, a ten minute break every hour is recommended as looking at the screen continuously can cause eye strain.

SPECIAL NOTES ON LCD MONITORS

- The following symptoms are normal with LCD monitors and do not indicate a problem.

NOTE

- When you first turn on the LCD monitor, the picture may not fit in the display area because of the type of computer that is used. In this case, adjust the picture position to the correct position.
 - You may find slightly uneven brightness on the screen depending on the desktop pattern you use.
 - Due to the nature of the LCD screen, an afterimage of the previous screen may remain after switching the image, when the same image is displayed for hours. In this case, the screen is recovered slowly by changing the image or turning off the Power Switch for hours.
- This LCD cannot be used outdoors.
 - This LCD cannot be used with the screen facing upwards.
 - If you use a cable longer than the supplied one, the picture quality is not guaranteed. Touch function can be disrupted if the USB cable length exceeds 3m.

USAGE CONFIRMATION

This product is designed for optimum usage at 18hours per day.
The display is compatible for usage in Landscape/Portrait applications.

IMAGE PERSISTENCE / IMAGE STICKING

Please be aware that all LCD screens can experience Image Persistence or Image Sticking. This occurs when a residual image remains visible on a screen when static images are displayed for long periods of time. LCD Image Persistence is not permanent but constant images being displayed for a long period of time should be avoided.

To counteract Image Persistence, turn off the monitor for as long as the previous image was displayed, so if an image was on the monitor for 1 hour and there is evidence of a residual or “ghost” image, you should turn off the monitor for 1 hour in order to clear the residual image.

For all LFD products, iiyama recommends displaying moving images and utilising a moving screen saver at regular intervals whenever the screen is idle. You could also turn off the monitor when not in use to assist the prevention.

Other ways to reduce the risk of Image Persistence will be to utilise the FAN-on function (if available), Low Backlight and Low Brightness settings.

FOR EXTENDED USE AS A PUBLIC DISPLAY

■ Image Sticking on LCD Panel

When a static image is displayed for hours, an electric charge trace remains near the electrode inside the LCD producing a “ghost” image. (Image Persistence).

Image Persistence is not a permanent feature.

■ Recommendations

To prevent Image Sticking and promote longer life expectancy of display, we recommend the following:

1. Avoid static images displayed for long periods – change static images on continuous loop.
2. Turn off monitor when not in use, either by remote control or use Power Management or Schedule functions.
3. When monitor is installed in high ambient temperature environment(s) or in an enclosed position, utilise the Cooling Fan, Screen Saver and Low Brightness functions.
4. Suitable ventilation for any monitor is an expectation of any installation – climate control systems may need to be employed.
5. We strongly recommend utilisation of active cooling with fans for long operation times or high ambient temperature environments.

CUSTOMER SERVICE

NOTE

- If you have to return your unit for service and the original packaging has been discarded, please contact your dealer or iiyama service center for advice or replacement packaging.

CLEANING

WARNING

- If you drop any materials or liquids such as water into the monitor when cleaning, unplug the power cable immediately and contact your dealer or iiyama service center.

CAUTION

- For safety reasons, turn off the power switch and unplug the monitor before you clean it.

NOTE

- To protect the LCD panel, do not scratch or rub the screen with a hard object.
- Never use any of the following strong solvents. These will damage the cabinet and the LCD screen.

Thinner	Benzine	Abrasive cleaner
Spray-type cleaner	Wax	Acid or Alkaline solvent

- Touching the cabinet with any product made from rubber or plastic for a long time may cause degeneration or loss of paint on the cabinet.

CABINET

Stains can be removed with a cloth lightly moistened with a mild detergent solvent. Then wipe the cabinet with a soft dry cloth.

LCD

Periodic cleaning with a soft dry cloth is recommended.

SCREEN

Don't use tissue paper etc. because these will damage the LCD screen.

BEFORE YOU OPERATE THE MONITOR

FEATURES

- ◆ Supports Resolutions up to 1920 × 1080
- ◆ High Contrast 3000:1 (Typical: without Touch panel) / Brightness 400cd/m² (Typical: without Touch panel)
- ◆ Digital Character Smoothing
- ◆ Automatic Set-up
- ◆ Stereo Speakers
2 × 10W Stereo Speakers
- ◆ Plug & Play VESA DDC2B Compliant
Windows[®] XP/Vista/7/8/8.1/10 Compliant
- ◆ Power Management (VESA DPMS Compliant)
- ◆ VESA Mounting Standard (400mm×400mm) Compliant
- ◆ Glass with AG coating : ProLite TH4265MIS-B1AG

ENGLISH

CHECKING THE CONTENTS OF THE PACKAGE

The following accessories are included in your package. Check to see if they are enclosed with the monitor. If anything is missing or damaged, please contact your local iiyama dealer or regional iiyama office.

- | | | |
|----------------------------------|--|---------------------|
| ■ Power Cable* ¹ | ■ VGA Cable | ■ HDMI Cable |
| ■ USB Cable* ² | ■ Remote Control | ■ Battery (2pcs) |
| ■ Touch Pen (3pcs)* ² | ■ Cable Ties (For Cable management) (6pcs) | |
| ■ iiyama Logo Sticker | ■ Safety Guide | ■ Quick Start Guide |

CAUTION

*¹ The rating of the Power Cable enclosed in 120V area is 10A/125V. If you are using a power supply higher than this rating, then a power cable with a rating of 10A/250V must be used. However, all guarantees and warranties are void for any problems or damage caused by a power cable not supplied by iiyama.

An approved power cable greater or equal to H05VVf, 3G, 0.75mm² must be used.

*² Accessory for ProLite TH4265MIS.

UNPACKING

- ① Before unpacking your monitor, prepare a stable, level, and clean surface near a wall outlet. Set the LCD Monitor box in an upright position and open from the top of the box before removing the top cushions.
- ② Remove the carton holders.
- ③ Remove the top cushion and take the accessories box and the Monitor out.

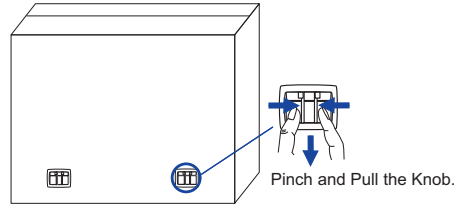

CAUTION

Moving the monitor requires at least two people. If not, it may drop and could result in a serious injury.

When moving/shipping the monitor, please hold by the carton holders.



SPECIAL NOTES ON : ProLite TH4265MIS

CAUTION

Permanent damage can occur if Sharp Edged, Pointed or Metal items are used to activate Touch. This could invalidate any remaining warranty.

We recommend you use a plastic stylus (tip R0.8 or over) or finger.

CONTROLS AND CONNECTORS : MONITOR

ENGLISH

<Back Controller>

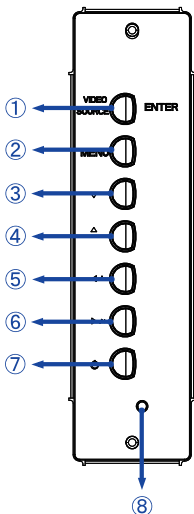

①	ENTER / VIDEO SOURCE	Enter/Input Select Button
②	MENU	Menu Button
③	▼	Down Button
④	▲	Up Button
⑤	◀ / -	Left / - Button
⑥	▶ / +	Right / + Button
⑦	⏻	Power Button

■ ProLite LH4265S

<Back>

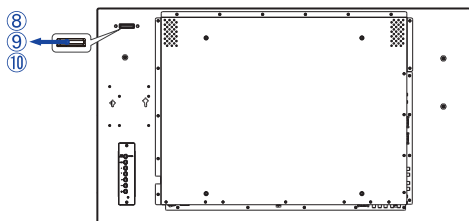

■ ProLite TH4265MIS

<Front>

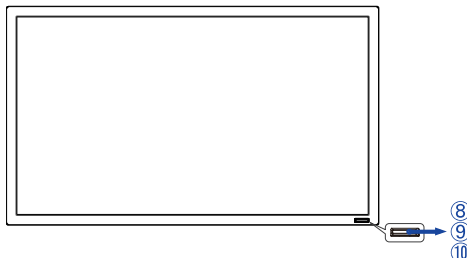

⑧	Power Indicator	Green	Normal Operation
		Red	Flash : Power Management Lighting : If turn off the Power Button on the Remote Control and the Back Controller.
		Off	Power Off
⑨	Remote Sensor	Remote Sensor	
⑩	Ambient Light Sensor	Detects ambient lighting conditions around the Monitor and adjusts screen brightness automatically when the Ambient Light Sensor function is activated.	

<Back>

■ ProLite LH4265S

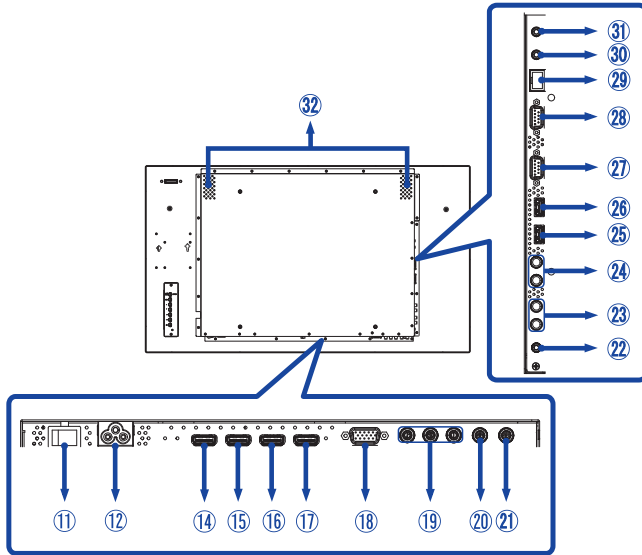

■ ProLite TH4265MIS

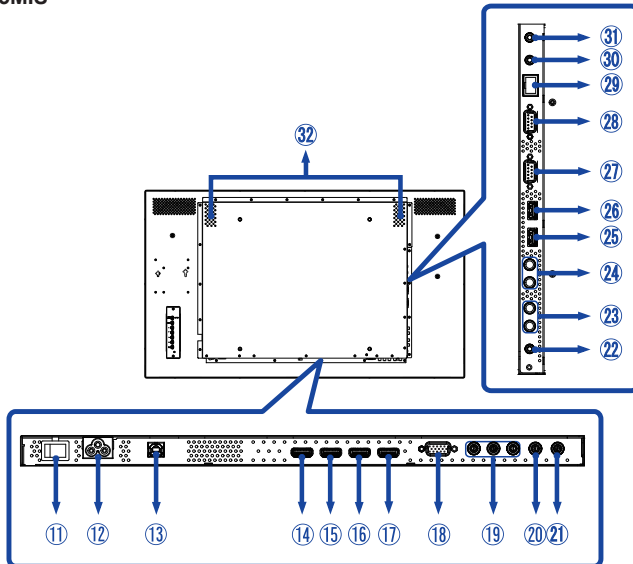

⑪	AC SWITCH I (ON) / O (OFF)	MAIN POWER	Main Power Switch
⑫	AC IN	AC-INLET	AC Connector(~ : Alternating current) (AC-IN)
⑬	USB Touch *	USB	USB Connector
⑭ ⑮ ⑰	HDMI1 IN / HDMI2 IN / HDMI3 IN	HDMI	HDMI Connector
⑯	HDMI3 OUT	HDMI	HDMI Connector
⑱	VGA IN	VGA	VGA Connector
⑲	COMPONENT VIDEO (VIDEO IN)	RCA G/B/R	Component Video Connector
⑳	AV IN	RCA	Video Connector
㉑	AV OUT	RCA	Video Connector
㉒	AUDIO IN1 (PC Audio In)	Mini Jack	Audio Connector
㉓	AUDIO IN2	RCA L/R	Audio Connector
㉔	AUDIO OUT	RCA L/R	Headphone Connector
㉕ ㉖	USB1 / USB2 Media player	USB	USB Connector
㉗	RS232C OUT	RS232C 9pin	RS232C Connector
㉘	RS232C IN	RS232C 9pin	RS232C Connector
㉙	LAN	RJ45	RJ45 Connector
㉚	IR OUT	IR	IR Connector
㉛	IR IN	IR	IR Connector
㉜	SPEAKERS		Speakers

* Available for ProLite TH4265MIS only.

INSTALLATION

CAUTION

- Follow the manual instructions for the type of mount you have selected. Refer all servicing to qualified service personnel.
- Moving the monitor requires at least two people.
- Before installing, please make sure the wall is strong enough to hold the necessary weight of the display and the mount.

[WALL MOUNTING]

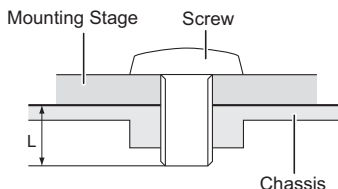

CAUTION

When using the wall mounting, consideration of thickness of the mounting stage needs to be taken. Tighten the M6 Screw with washer which "L" length is 10mm to fasten the monitor. Using a screw longer than this may cause electric shock or damage because it may contact with the electrical parts inside the monitor.

[INSTALLATION NOTE] *Available for ProLite TH4265MIS only.

The touch kit of this monitor is an optical device that utilizes infrared light source and sensitive sensors for touch detection.

Notice the incident light that contains large quantities of infrared light may affect touch screen operation and performance.

Please install it with care as follows to ensure reliable touch performance.

Intense light / Specular light / Focus spotlight / Wide spread light / Direct sunlight / Indirect sunlight from the window and/or the glass door. / Not install the touch monitor right under the light source.

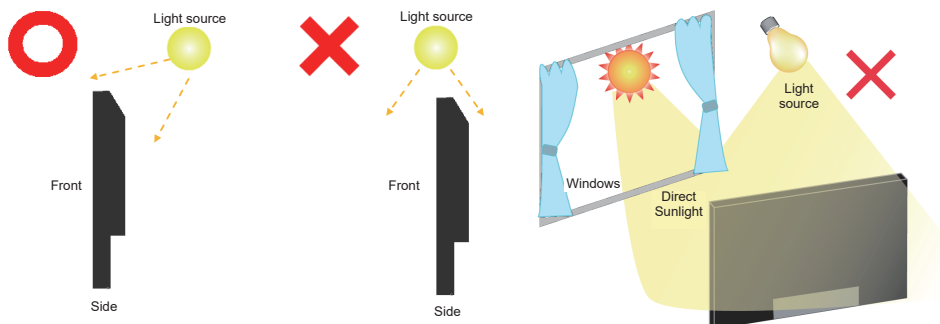

[ROTATING THE DISPLAY]

It is designed to be compatible in both landscape and portrait modes.

ENGLISH

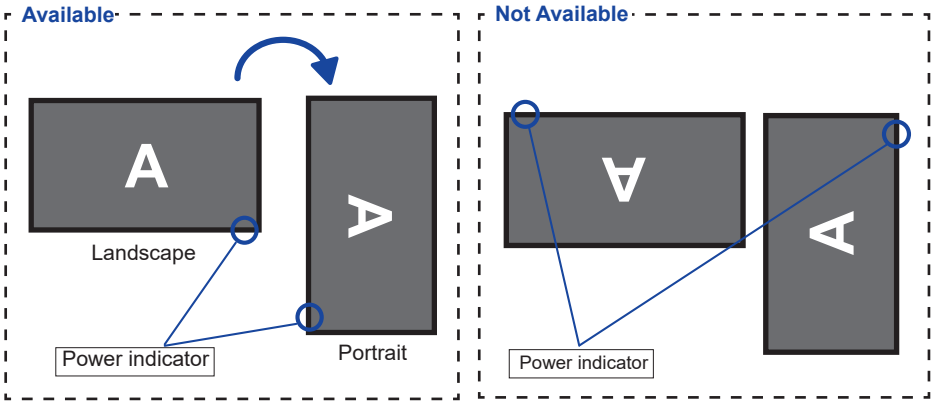

CONTROLS AND CONNECTORS : REMOTE CONTROL

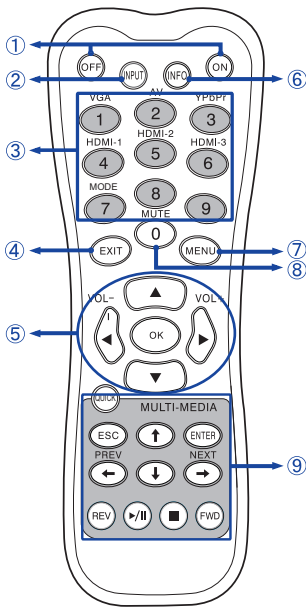

①	ON/OFF	Turns the monitor ON and OFF.
②	INPUT	Selects the source.
③	Number (1-9) / Input source	Serve as input source buttons when the Menu is not displayed.
④	EXIT	Returns to a previous menu or closes the OSD Menu.
⑤	▲▼◀▶	Navigates through submenus and settings. ▲: Up Button ▼: Down Button ◀: Left Button ▶: Right Button ◀(VOLUME-): Decreases the sound volume. ▶(VOLUME+): Increases the sound volume.
	OK	Confirms your selection or save changes.
⑥	INFO	Provides source and resolution information.
⑦	MENU	Opens the monitor's on-screen menu systems. When the menu system is already open, pressing this button will select the previous submenu.
⑧	Number (0)/ MUTE	Turns on or off the mute function when the Menu is not displayed.
⑨	MULTI-MEDIA	QUICK: Goes back to the main page. ESC: Goes back to the previous page. ENTER: Activates the selected menu item. ←(PREV)/ ↑ / ↓ / →(NEXT): Directional arrows for selecting a desired item. REV: Quick-Return ▶ / : Play / Pause ■ : Stop FWD: Fast-Forward

PREPARING THE REMOTE CONTROL

To use the remote control, insert the two dry batteries.

CAUTION

Do not use any other batteries other than those specified in this manual for the Remote Control. Do not insert old and new batteries together in the Remote Control. Make sure that the terminals match the "+" and "-" indications in the battery compartment. Burst batteries or the electrolyte from these batteries may cause stains, fire or injury.

- ① Slide back and remove the battery cover in the direction of the arrow.

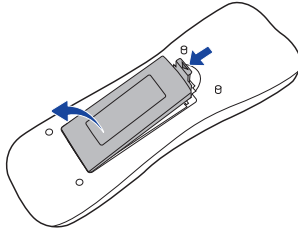

- ② Align and insert two AAA batteries according to their plus and minus ports (as indicated in the remote control).

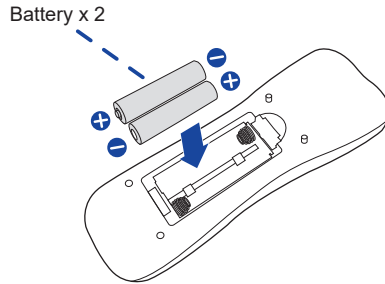

- ③ Replace the battery cover in the direction of the arrow and snap it back into place.

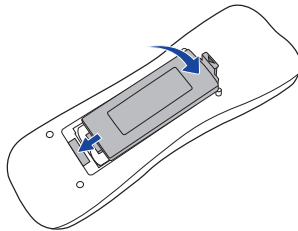

NOTE

- Replace with new batteries when the Remote Control does not work close to the monitor. Use AAA dry batteries.
- Operate the Remote Control by pointing it toward the Remote Sensor on the monitor.
- Other manufacturers remote control will not work with this monitor. Use the provided Remote Control ONLY.
- Used batteries needed to follow the local rules to be discarded. (Suggestion: to dispose of used batteries please follow correct policy as per your local regulations.)

BASIC OPERATION

■ Turning the monitor ON

The monitor is turned On and the Power Indicator turns to Green when you press the POWER Button on the monitor or the Remote Control. The monitor is turned Off and the Power Indicator turns to Red when you press the POWER Button on the monitor or the Remote Control.

Press again to turn On the monitor.

NOTE

Even when using the power management mode or turning OFF the Power Switch, the monitor will consume a small amount of electricity. Disconnect the Power Cable from the power supply whenever the monitor is not in use or during the night, to avoid unnecessary power consumption.

[Monitor]

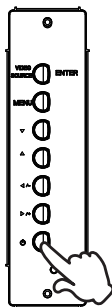

[Remote Control]

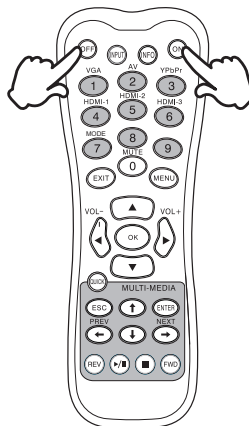

■ Display the adjustment menu page

The menu page appears on the screen when you press the MENU Button on the monitor or the Remote Control.

The menu page disappears when you press the EXIT Button on the Remote Control again.

[Monitor]

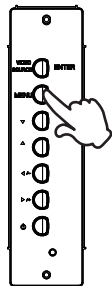

[Remote Control]

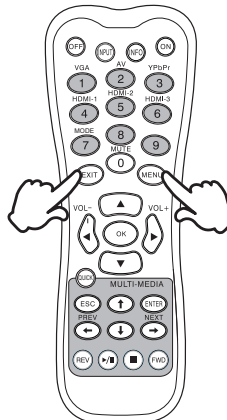

■ Move the cursor vertically

Select adjustment by pressing the ▲ / ▼ Button while the menu page is displayed on the screen.

[Monitor]

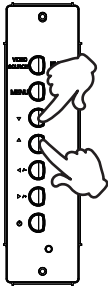

[Remote Control]

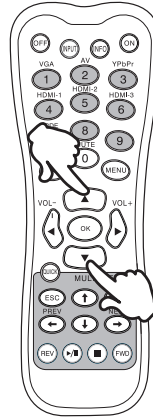

■ Move the cursor horizontally

Select menu or setting, or perform the adjustment by pressing the ◀ / ▶ Button while the menu page is displayed on the screen.

[Monitor]



[Remote Control]

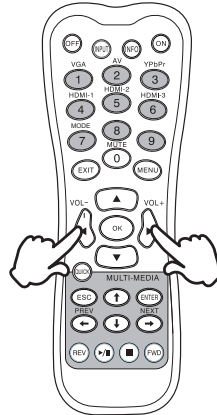

■ Adjust the volume of sound

Press the ◀/▶ Button to adjust the volume of sound when the menu page is not displayed on the screen.

[Monitor]

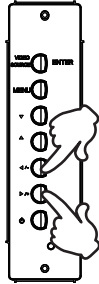

[Remote Control]

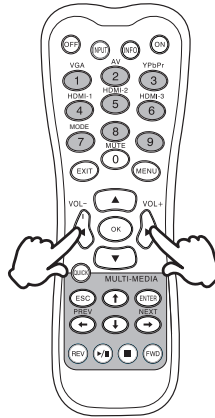

■ Switch the input signal

This is activated when you successively press the VIDEO SOURCE Button on the monitor or INPUT Button on the Remote Control as follows:

[Monitor]

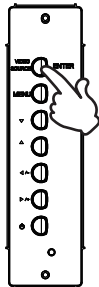

[Remote Control]

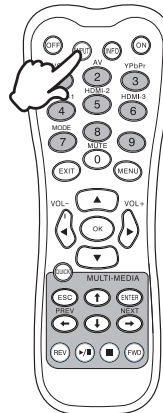

CONNECTING YOUR MONITOR

- ① Ensure that both the computer and the monitor are switched off.
- ② Connect the computer to the monitor with the signal cable.
- ③ Connect the computer to the monitor with the USB Cable.*
- ④ Connect the Power Cable to the monitor first and then to the power supply.
- ⑤ Turn on your monitor (Main Power Switch and Power Switch) and computer.

NOTE

- The signal cables used for connecting the computer and monitor may vary with the type of computer used. An incorrect connection may cause serious damage to both the monitor and the computer. The cable supplied with the monitor is for a standard connector. If a special cable is required please contact your local iiyama dealer or regional iiyama office.
- For connection to Macintosh computers, contact your local iiyama dealer or regional iiyama office for a suitable adaptor.
- Make sure you tighten the finger screws at each end of the Signal Cable.
- When USB cable connected than wait for 5 seconds and the touch function is ready to go. It can be activated by pen, finger or any other pointer.*
- The Class I pluggable equipment Type A must be connected to protective earth.
- The socket-outlet shall be installed near the equipment and shall be easily accessible.
- Excessive sound pressure from ear-/headphones can cause hearing damage/hearing loss.

[Example of Connection]

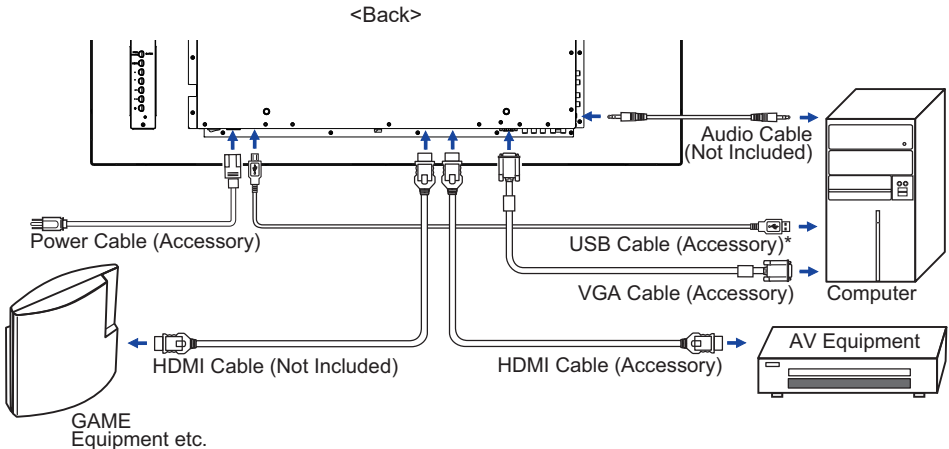

* Available for ProLite TH4265MIS only.

[About the daisy chain]

■ Monitor control connection

RS-232C

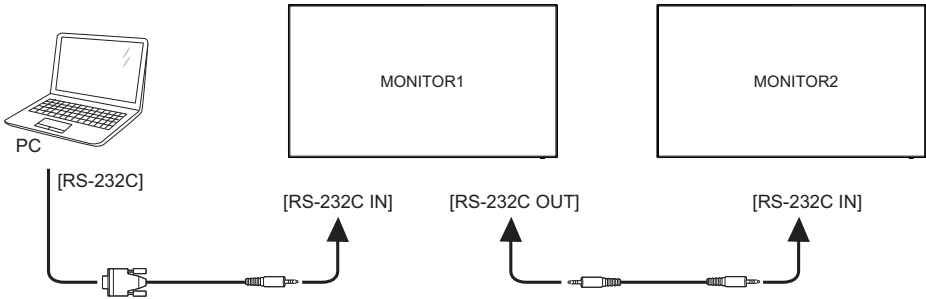

■ Digital video connection

HDMI

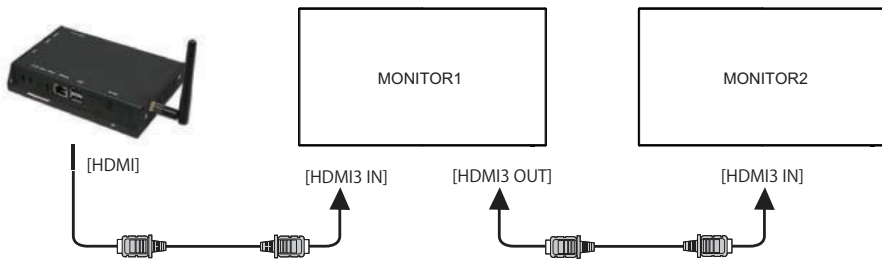

[Network Connection]

●Connecting to a LAN

To set the monitor to connect to a local area network.

1. Connect a RJ45 cable to the corresponding ports on the monitor and your LAN switch or router.
2. Select the LAN in the Control Setting of the OSD menu.
3. Set the Network Settings of the OSD menu. (IP Address Setup / DNS Setup)
4. Save the settings and return to the previous menu.

●Controlling the Monitor

Once you have the correct IP Address for your monitor and the monitor is on or in standby mode, you can use any computer that is on the same local area network to control the monitor.

- NOTE**
- You can not control the monitor via the RS-232C connector when LAN control is in use.
 - It is recommended that you use a recent Internet Explorer browser version.

1. Enter the IP Address of the monitor in the address bar of your browser and press ENTER button.

2. Input ID and Password.

ID: admin

Password: system

3. The setting page appears.

INFORMATION / PICTURE&SOUND / SCREEN / SETTING / SCHEDULE / MAIL REPORT / NETWORK

- NOTE** If you would like to turn on the monitor from a web page.

Make sure the setting > Control setting menu is set to LAN, and the setting > Power Save menu is set to Off.

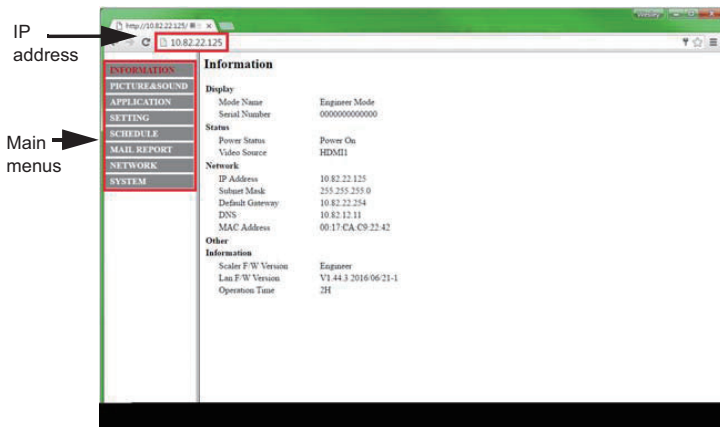

COMPUTER SETTING

■ Signal Timing

Change to the desired signal timing listed on page 47: COMPLIANT TIMING.

■ Windows XP/Vista/7/8/8.1/10 Plug & Play

The iiyama LCD monitor complies with DDC2B of VESA standard. The Plug & Play function runs on Windows XP/Vista/7/8/8.1/10 by connecting the monitor to DDC2B compliant computer with the Signal Cable supplied.

For installation on Windows XP: The monitor Information File for iiyama monitors may be necessary for your computer and obtained via the Internet, using the address:

<http://www.iiyama.com>

NOTE

- For additional information on how to download the driver for your touch screen monitor, please access the internet site noted above.
 - Monitor Drivers are not required in most cases for Macintosh or Unix operating systems. For further information, please contact your computer dealer first for advice.
-
- Procedure for turning ON the Power Switch
Turn ON the monitor first, and then the computer.

■ MULTI-TOUCH :

ProLite TH4265MIS

This monitor complies with DDC2B of VESA standard. (Plug&play compliant)

The MULTI-TOUCH function runs on Windows7/8/8.1/10 by connecting the monitor to DDC2B compliant computer with the USB cable supplied.

■ TOUCH support operation system :

ProLite TH4265MIS

Microsoft Windows XP (64 bit and 32 bit)

Microsoft Windows Vista (64 bit and 32 bit)

Microsoft Windows 7 (64 bit and 32 bit)

Microsoft Windows 8/8.1 (64 bit and 32 bit)

Microsoft Windows 10 (64 bit and 32 bit)

Mac OS X V10.6.4 & higher HID for single touch only

10.10 - 10.11 need calibration or driver installation.

Linux 3.0 & higher need patch for multi-touch

3.5 & higher HID for multi-touch

Not support Windows earlier versions.

	Windows10	Windows8/8.1*6	Windows7*5	Windows7*4	Vista	XP	Mac OSX	Linux
Default mouse*1	○	○	○	○	○	○	○	○
Touch digitizer*2	○	○	○	○	○	×	×	×
Windows gestures*3	○*7	○	○	×	×	×	×	×

*1 Default mouse (click, drag, double-click and right-click)

*2 Touch digitizer (click, drag /selection, double-click, right-click, flick and visual feedback)

*3 Digitizer with Windows7 multi-touch gestures

*4 Windows 7 - Starter and Home Basic version

*5 Windows 7 - Home Premium, Professional, Enterprise and Ultimate versions

*6 Windows 8/8.1 need non-OEM version for multi-touch support

*7 Not support Windows10 Pad Gesture

OPERATING THE MONITOR

To create the best picture, your iiyama LCD monitor has been preset at the factory with the COMPLIANT TIMING shown on page 47. You are also able to adjust the picture by following the button operation shown below. For more detailed adjustments, see page 37 for SCREEN ADJUSTMENTS.

- 1 Press the MENU button to start the On Screen Display feature. There are additional Menu items which can be switched by using the ▲ / ▼ buttons.

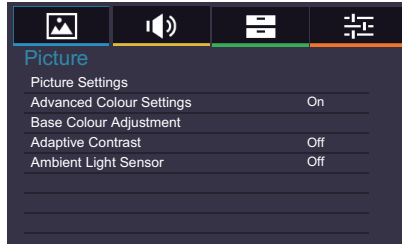

- 2 Select the Menu item of the adjustment you want to make. Press the OK button on the remote control or ENTER button on the monitor and enter the menu page. Then, use the ▲ / ▼ buttons to highlight the desired adjustment item.
- 3 Press the OK button on the remote control or ENTER button on the monitor again. Use the ◀ / ▶ buttons to make the appropriate adjustment or setting.
- 4 Press the EXIT button to leave the menu, and the settings you just made would be automatically saved.

For example, to correct for vertical position, select Menu item of Screen. Select "Settings" by using the ▲ / ▼ buttons. Press the OK button on the remote control. Next, select "VGA Settings" by using the ▲ / ▼ buttons. Press the OK button on the remote control. Then, select "V. Position" by using the ▲ / ▼ buttons.

Use the ◀ / ▶ buttons to change the vertical position settings. The vertical position of the overall display should be changing accordingly while you are doing this.

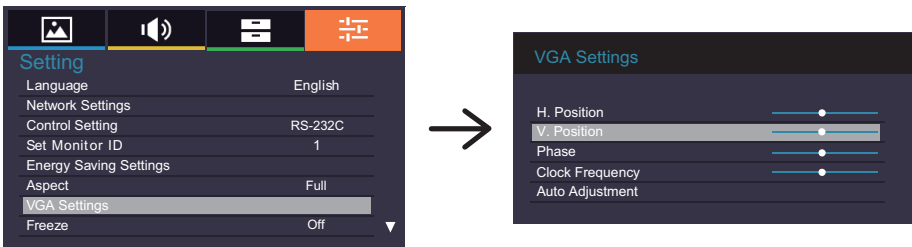

Press the EXIT button on the remote control lastly, it ends, all changes are saved in the memory.

NOTE

- The EXIT button on the remote control can be used to return previous menu item.
- Any changes are automatically saved in the memory when the On Screen Display disappears. Turning off the power should be avoided while using the Menu.
- Adjustments for Image Position, Clock Frequency and Phase are saved for each signal timing. Except for these adjustments, all other adjustments have only one setting which applies to all signal timings.

[LOCK MODE]

- **Back Controller Button:** * Available Back Controller only.
Pressing and holding the ◀ / - and ▶ / + buttons for about 5 seconds when Menu is not displayed, will lock/unlock the Back Controller Button Lock function.
- **Remote Control Button:** * Available Back Controller only.
Pressing and holding the MENU and ◀ / - buttons for about 5 seconds when Menu is not displayed, will lock/unlock the Remote Control Button Lock function.
- **Back Controller Button & Remote Control Button:** * Available for Remote Control only.
Press and hold the ▼ button for about 5 seconds, then press the OK button when Menu is not displayed to activate/deactivate the Back Controller and Remote Control Lock function.

Direct * Available for Remote Control only.

- **Freeze Function:**
Press the ▼ button and then press 0 button when Menu is not displayed.
Repeat successively to activate/deactivate the function.
- **Automatic Power Down Function:**
Press the ▲ button and then press 0 button when Menu is not displayed and "Automatic Power Down" is turned On.
Will be disabled any time a button is pressed.

ADJUSTMENT MENU CONTENTS

Picture

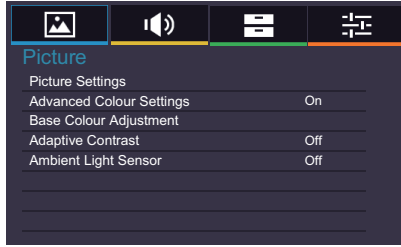

Adjustment Item		Problem / Option		Button to Press	
Picture Settings	Picture Mode	Vivid	For displaying outdoor scenery images.		
		Standard	For general windows environment and monitor default setting.		
		Cinema	For movie and video environment.		
		Custom	Displays a picture on a screen set by Image Settings adjustments.		
	Backlight* ³	Brightness of back light is reduced.		← ▶	
	Contrast	Too dull		← ▶	
		Too intense		← ▶	
	Brightness* ¹	Too dark		← ▶	
		Too bright		← ▶	
	Saturation* ²	Too weak		← ▶	
		Too strong		← ▶	
	Hue* ⁴	Purplish		← ▶	
		Greenish		← ▶	
	Sharpness	Too soft		← ▶	
Too sharp			← ▶		
Contrast Booster	Off	Contrast Booster is turned off.			
	Low	Improves the contrast of the picture.			
	Middle	Improves the contrast of the picture more than Low.			
	High	Improves the contrast of the picture more than Middle.			
Color Temp.	Cool (Bluish white)	Red Level	Too weak Too strong	← ▶	
	Neutral (Greenish white)	Green Level			
	Warm (Reddish white)	Blue Level			
	Custom	Reset	No	Return to Menu.	
			Yes	Resets all settings in the Color Temp. menu.	

Picture

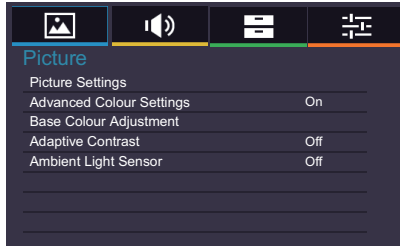



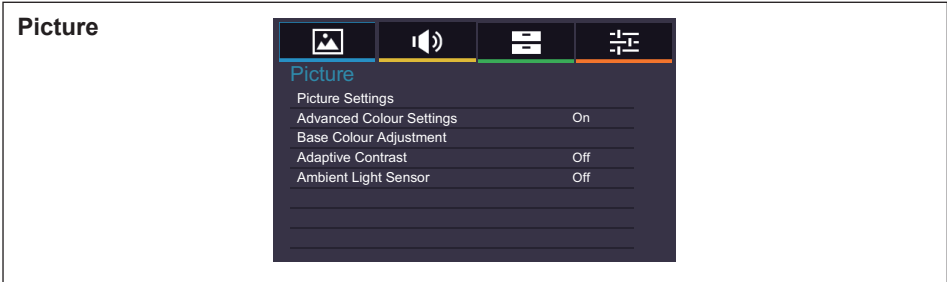



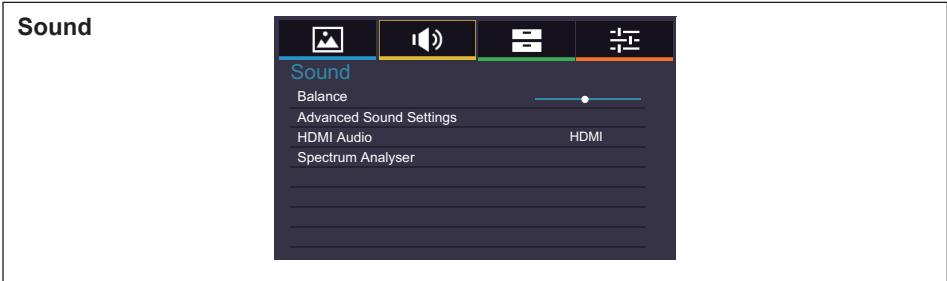

Adjustment Item		Problem / Option		Button to Press
Picture Settings	Noise Reduction*2	Auto Clean	On	The function reduces (grained) noise of a compressed or converted MPEG signal. It may also improve the quality of blurry pictures.
			Off	Auto Clean is turned off.
		MPEG NR	Off	MPEG NR is turned off.
			Low	Sets the MPEG NR noise reduction level.
			Middle	Sets the MPEG NR noise reduction level more than Low.
		DNR	High	Sets the MPEG NR noise reduction level more than Middle.
			Off	DNR is turned off.
			Low	Sets the DNR noise reduction level.
			Middle	Sets the DNR noise reduction level more than Low.
	Reset	High	Sets the DNR noise reduction level more than Middle.	
No		Return to Menu.		
Advanced Colour Settings	Yes	Resets all settings in the Picture Settings menu.		
	On	Enable the Base Color Adjustment.		
Base Colour Adjustment	Off	Disable the Base Color Adjustment.		
	Adjusts the parameter of Hue, Saturation and Brightness.			
	Red	Too weak Too strong		
	Green			
	Blue			
	Yellow			
	Magenta			
	Cyan			
Reset	No	Return to Menu.		
	Yes	Resets all settings in the Base Colour Adjustment menu.		
Adaptive Contrast	On	Enhances image contrast for dark scenes.		
	Off	Adaptive Contrast is turned off.		



Adjustment Item	Problem / Option		Button to Press
Ambient Light Sensor	On	Automatically adjust image brightness to changing ambient lighting conditions.	
	Off	Ambient Light Sensor is turned off.	

- *1 Adjust the Brightness when you are using the monitor in a dark room and feel the screen is too bright.
- *2 Only AV, YPbPr and HDMI(Video) inputs.
- *3 Backlight is disabled when the Ambient Light Sensor or Adaptive Contrast is active.
- *4 Only AV(NTSC) input.



Adjustment Item	Problem / Option		Button to Press		
Balance	Left side speaker louder Right side speaker louder		   		
Advanced Sound Settings	Sound Mode	Natural	Bass	Too weak	   
		Clear Voice	Treble	Too strong	
		Dynamic	Reset	No	Return to Menu.
		Standard		Yes	Resets all settings in the Advanced Sound Settings menu.
HDMI Audio	HDMI		Selects the HDMI input.		
	Line-In		Selects the Line-In input.		
Spectrum Analyser	Displays the spectrum analyser for the selected audio source.				

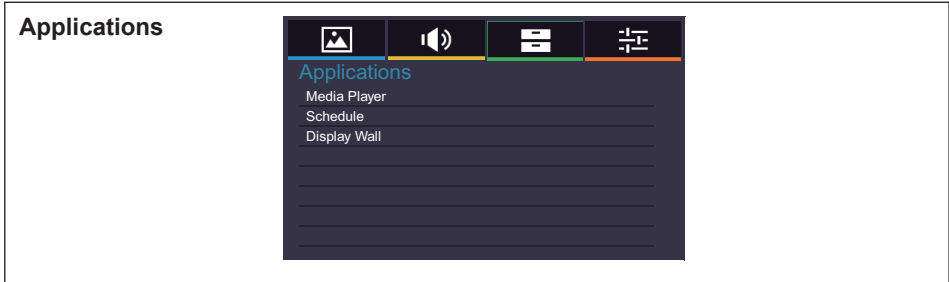

Adjustment Item	Problem / Option		Button to Press	
Media Player	Photos	Displays a list of Photos in USB1/USB2.		
	Music	Displays a list of Music in USB1/USB2.		
	Videos	Displays a list of Videos in USB1/USB2.		
Schedule	Date and Time *	Displays the current date and time. Year/Month/Day/Hour/Minute Time set / Date set		
	Clock Display	On	Displays time.	
		Off	Clock Display is turned off.	
On/Off Timer	Sets when to turn on or off the display. On/Off/Everyday/Mon/Tue/Wed/Thu/Fri/Sat/Sun			
Display Wall	H Monitors	Sets the number of displays used in the horizontal position.		
	V Monitors	Sets the number of displays used in the vertical position.		
	H Position	Sets the horizontal position of the display wall matrix.		
	V Position	Sets the vertical position of the display wall matrix.		
	Frame comp.	On	Adjusts images near the display edges for optimal demonstration across the display wall.	
		Off	Return to Menu.	
	LED	On	The power indicator is turned on.	
		Off	The power indicator is turned off.	
Power On Delay	On	All Display wall monitors will power on randomly within 10 seconds.		
	Off	Power On Delay is turned off.		

* You must set this item when using "On/Off Timer".

Setting

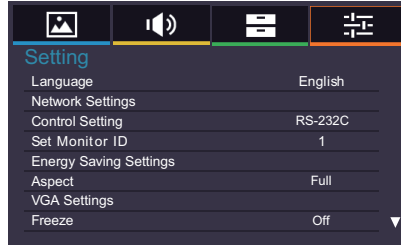

Adjustment Item		Problem / Option		Button to Press	
Language		English	English	Русский	Russian
		Français	French	Čeština	Czech
		Deutsch	German	Italiano	Italian
		Nederlands	Dutch	日本語	Japanese
		Polski	Polish		
Network Settings		IP Address Setup	Auto Setup	On	Once you are connected, the IP Address, Subnet mask and Default gateway settings are displayed.
				Off	If you are not connected, contact your IT administrator for information on the IP Address, Subnet mask and Default gateway settings and enter them accordingly.
		DNS Setup	Auto Setup	On	Once you are connected, the Primary DNS settings is displayed.
				Off	If you are not connected, contact your IT administrator for information on the Primary DNS settings and enter them accordingly.
		MAC Address	Displays the address of the MAC which is connected.		
Control Setting		RS-232C	Selects the RS-232C to control the display.		
		LAN	Selects this option to control the display via LAN.		
		IR Passthrough	Selects this option if multiple displays are connected via RS-232C cables. Primary/Secondary NOTE To reset to the default settings (IR Passthrough Primary, press the INFO button on the remote control for 5 seconds.		
Set Monitor ID *1		Set ID to the Monitor. 1-98			
Energy Saving Settings	Power Save *2	On	All input sources can activate entering the power saving mode, but only the VGA signal can deactivate it. If an another input source is connected you have to press the POWER button.		
		Off	Power Save is turned off.		

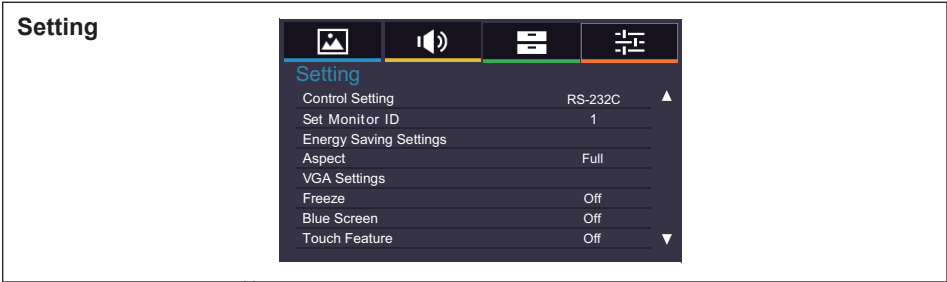

Adjustment Item		Problem / Option		Button to Press
Energy Saving Settings	Automatic Power Down Direct	On	Enable the Automatic Power Down function. NOTE <ul style="list-style-type: none"> The monitor will turn off automatically after 3 hours without any key operation. When this function is on, pressing the ▲ button and then the 0(MUTE) button on the remote control can turn this function off. 	
		Off	Automatic Power Down is turned off.	
Aspect		Zoom* ³	Enlarge the picture, keeping its original aspect ratio.	
		4:3* ³	Displays all picture in 4:3 aspect ratio.	
		Wide zoom* ³	Enlarge to fill screen with minimum distortion.	
		Full	Enlarge the picture horizontally to fill the screen if the picture source is 4:3 (standard definition). When the picture source is 16:9 (high definition), it is not scaled.	
		Normal* ⁴	Enlarges the picture to fill the screen in the vertical direction, keeping the same aspect ratio.	
		Real* ⁴	Displays the picture dot by dot.	
VGA Settings * ⁵		H. Position	Too far to the left Too far to the right	
		V. Position	Too low Too high	
		Phase	To correct flickering text or lines	
		Clock Frequency	Too narrow Too wide	
		Auto Adjustment* ⁶	Adjusts Position, Clock Frequency and Phase automatically.	
Freeze	Direct	On	Freezes the picture.	
		Off	Freeze is turned Off.	
Blue Screen		On	Displays a blue screen when no input signal is detected.	
		Off	Blue Screen is turned Off.	

Direct See page 25 for Direct.

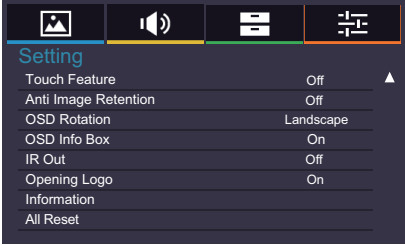
Setting			
			
Adjustment Item	Problem / Option		Button to Press
Touch Feature*7	On	Enable the touch function. NOTE Display wall will be disabled to optimize touch performance.	
	Off	Return to Menu.	
Anti Image Retention	On	Automatically displays swift moving patterns every 1 second to prevent image retention on the screen.	
	Off	Image Retention is turned off.	
OSD Rotation	Landscape	Landscape display	
	Portrait	Portrait display	
OSD Info Box	On	Switching signal inputs, or changing timing, the current input source and resolution information will be displayed on the screen.	
	Off	OSD Info Box is turned off.	
IR Out	On	To operating multiple monitors with one remote control. Multiple monitors to connect using the IR cables.	
	Off	IR Out is turned off.	
Opening Logo	On	iiyama Logo displayed when the monitor is turned on.	
	Off	iiyama Logo does not display when the monitor is turned on.	
Information	Date/Model Name/Serial Number/Operation Time/Software Version/LAN Version/IP Address*8 NOTE See your graphic card user guide for more information about changing the resolution and refresh.		
All Reset	No	Return to Menu.	
	Yes	Factory-preset data is restored.	

*1 For use under the RS-232C control mode.

*2 RS-232C can bring any mode out of the power saving status.

*3 Only AV, YPbPr and HDMI(Video) inputs.

*4 Only VGA and HDMI(PC) inputs.

*5 Only VGA input.

*6 For best results, use the Auto Adjust in conjunction with the adjustment pattern. See page 37 for SCREEN ADJUSTMENTS.

*7 Available for ProLite TH4265MIS only.

*8 IP address is displayed only when LAN is connected.

[Play Multimedia Files]

You can play photos, music and videos on your monitor from:

- A USB device connected to this monitor.

● Play multimedia files from USB device

To play files on an external USB storage device, simply plug the device into the USB A jack on the monitor.

1. Connect your USB device to the USB port on this monitor.
2. Press the INPUT button, select Multi-media, then press the OK button.
3. Uses the remote control and follow the On - Screen instructions to operate.

■ USB Standard:

USB2.0

■ Supported file system:

FAT32

■ Supported file format:

- Music: MP3, MP4, WMA, WAV, MKA
- Video: AVI, MPG, MPEG, MOV, MP4, ASF, DivX, Xvid, MKV, RealMedia, FLV1, F4V, 3GPP
- Photo: JPEG, BMP, PNG

● Viewing photo files

<Remote control button functions in thumbnail view>

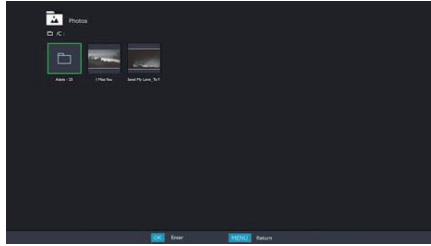

- **OK / ENTER** : Opens the selected photo file.
- **MENU / ESC** : Returns to the Media Player menu.
- **▲ / ▼ / ◀ / ▶** : Directional arrows for selecting a desired photo.
- **EXIT** : Closes the OSD menu or media player.

<Remote control button functions in browse mode>

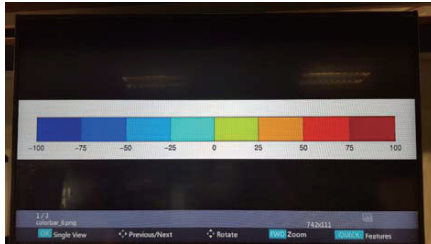

- **OK / ENTER** : Toggles between Slide Show mode or Single View mode.
- **◀** : Plays the next photo.
- **▶** : Plays the previous photo.
- **▲** : Rotates the image 90° clockwise.
- **▼** : Rotates the image 90° counterclockwise.
- **QUICK** : Opens the Quick menu.
- **MENU / ESC** : Goes back to the previous page.
- **FWD** : Zoom in
- **REV** : Zoom out
- **INFO** : Displays the current file status information.
- **EXIT** : Closes the OSD menu or media player.
- **0(MUTE)** : Mutes the sound.

<Quick Menu>

- **Picture Settings** : Opens the Picture Settings menu.
- **Interval Time** : Sets the Slide Show display interval time. 3 - 90 seconds
- **Device Information** : Displays the current device information.

●Playing music files

<Remote control button functions in thumbnail view>

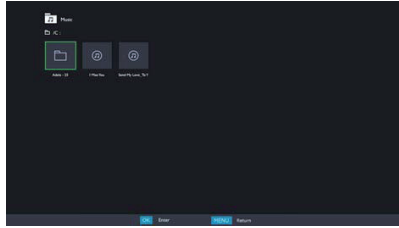

- **OK / ENTER** : Plays the selected music file.
- **MENU / ESC** : Returns to the Media Player menu.
- **▲ / ▼ / ◀ / ▶** : Directional arrows for selecting a desired music.
- **EXIT** : Closes the OSD menu or media player.

<Remote control button functions during playback>



- **←** : Plays the previous music file.
- **→** : Plays the next music file.
- **◀ / VOL-**, **▶ / VOL+** : Turns down/up the volume.
- **QUICK** : Opens the Quick menu.
- **MENU / ESC** : Goes back to the previous page.
- **FWD** : Fast forwards the music. Press repeatedly to change the speed at 1X, 2X, 3X or 4X.
- **REV** : Rewinds the music. Press repeatedly to change the speed at 1X, 2X, 3X or 4X.
- **INFO** : Displays the current file status information.
- **▶ / II** : Plays/pauses the music.
- **■** : Plays the file from the beginning.
- **EXIT** : Closes the OSD menu or media player.
- **0(MUTE)** : Mutes the sound.

<Quick Menu>

- **Sound** : Opens the Advanced Sound Settings menu.
- **Repeat** : Sets the file repeat mode.
 - Off : The file only plays once.
 - All : All files in the same folder play repeatedly.
 - 1 : The same file plays repeatedly.
- **Device Information** : Displays the current device information.

●Playing video files

<Remote control button functions in thumbnail view>

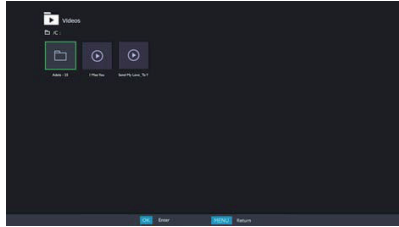

- **OK / ENTER** : Plays the selected video file.
- **MENU / ESC** : Returns to the Media Player menu.
- **▲ / ▼ / ◀ / ▶** : Directional arrows for selecting a desired video.
- **EXIT** : Closes the OSD menu or media player.

<Remote control button functions during playback>



- **←** : Plays the previous video file.
- **→** : Plays the next video file.
- **◀ / VOL-, ▶ / VOL+** : Turns down/up the volume.
- **QUICK** : Opens the Quick menu.
- **MENU / ESC** : Goes back to the previous page.
- **FWD** : Fast forwards the video. Press repeatedly to change the speed at 1X, 2X, 3X or 4X.
- **REV** : Rewinds the video. Press repeatedly to change the speed at 1X, 2X, 3X or 4X.
- **INFO** : Displays the current file status information.
- **▶ / ||** : Plays/pauses the video.
- **■** : Plays the file from the beginning.
- **EXIT** : Closes the OSD menu or media player.
- **0(MUTE)** : Mutes the sound.

<Quick Menu>

- **Picture Settings** : Opens the Picture Settings menu.
- **Picture Size** : Sets a preferred picture size. Normal / Wide Zoom / Zoom
- **Sound** : Opens the Advanced Sound Settings menu.
- **Repeat** : Sets the file repeat mode.
 - Off : The file only plays once.
 - All : All files in the same folder play repeatedly.
 - 1 : The same file plays repeatedly.
- **Device Information** : Displays the current device information.

SCREEN ADJUSTMENTS

Adjust the image by following the procedure below to get the desired picture when selecting Analog input.

- The screen adjustments described in this manual are designed to set image position and minimize flicker or blur for the particular computer in use.
- The monitor is designed to provide the best performance at resolution of 1920 × 1080, but can not provide the best at resolutions of less than 1920 × 1080 because the picture is automatically stretched to fit the full screen. It is recommended to operate at resolution of 1920 × 1080 in normal use.
- Displayed text or lines will be blurred or irregular in thickness when the picture is stretched due to the screen enlargement process.
- It is preferable to adjust the image position and frequency with the monitor controls, rather than the computer software or utilities.
- Perform adjustments after a warm-up period of at least thirty minutes.
- Additional adjustments may be required after the Auto Adjust depending on the resolution or signal timing.
- The Auto Adjust may not work correctly when displaying the picture other than the screen adjustment pattern. In this case, manual adjustments are required.

There are two ways to adjust the screen. One way is automatic adjustment for Position, Clock Frequency and Phase. The other way is performing each adjustment manually.

Perform the Auto Adjust first when the monitor is connected to a new computer, or resolution is changed. If the screen has a flicker or blur, or the picture does not fit in the display area after performing the Auto Adjust, manual adjustments are required. Both adjustments should be made by using the screen adjustment pattern (Test.bmp) obtained via the IYAMA web site (<http://www.iiyama.com>).

Adjust the image by following the procedure below to get the desired picture.
This manual explains adjustment under Windows® OS.

- ① **Display the picture at the optimum resolution.**
- ② **Enter the Test.bmp (screen adjustment pattern) to wallpaper.**

NOTE

- Consult the appropriate documentation for doing this.
- TSet the display position to center in the wallpaper setting dialogue box.

[Adjustment pattern]

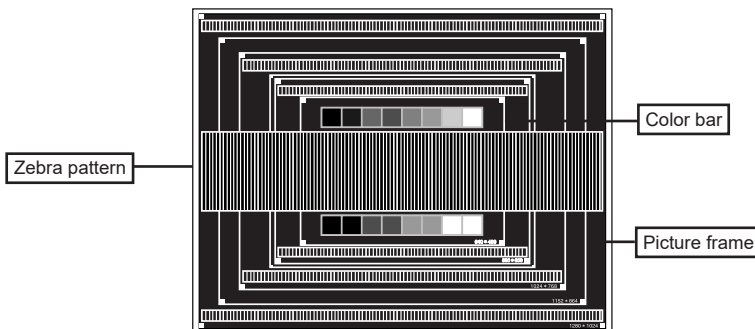

- ③ Adjust the Auto Adjustment.
- ④ Adjust the image manually by following procedure below when the screen has a flicker or blur, or the picture does not fit in the display area after performing the Auto Adjust.
- ⑤ Adjust the V-Position so that the top and bottom of the picture frame will fit to the display area.

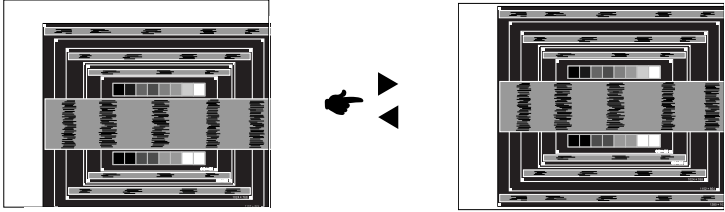

- ⑥ 1) Adjust the H-Position so that the left side of the picture frame will move to the left edge of the display area.

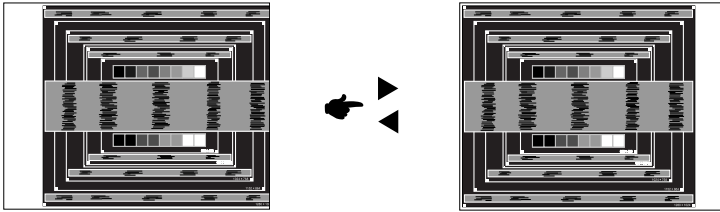

- 2) Stretch the right side of the picture frame to the right edge of the display area by adjusting the Clock Frequency.

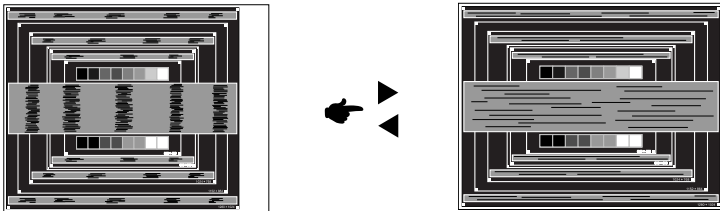
**NOTE**

- When the left side of the picture frame moves apart from the left edge of the display area during the Clock Frequency adjustment, adjust steps 1) and 2).
- Another way to make the Clock Frequency adjustment is to correct the vertical wavy lines in the zebra pattern.
- The picture may flicker during the Clock Frequency, H/V-Position adjustment.
- In case the picture frame is bigger or smaller than the data display area after the Clock Frequency adjustment, repeat steps from ③.

- ⑦ **Adjust the Phase to correct horizontal wavy noise, flicker or blur in the zebra pattern.**

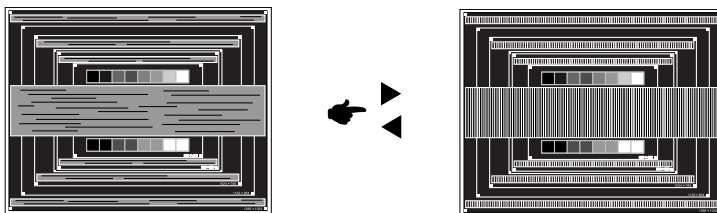

NOTE

- In case the strong flicker or blurs remain on a part of the screen, repeat steps ⑥ and ⑦ because the Clock Frequency may not be adjusted correctly. If the flicker or blurs still remain, set the refresh rate of computer to low (60Hz) and repeat steps from ③ again.
 - Adjust the H-Position after the Phase adjustment if the horizontal position moves during the adjustment.
- ⑧ **Adjust the Brightness and Color to get the desired picture after you complete the Clock Frequency and Phase adjustments.**
- Put back your favorite wallpaper.**

POWER MANAGEMENT FEATURE

The power management feature of this product complies with power saving requirement of VESA DPMS. When activated, it automatically reduces unnecessary power consumption of the monitor when your computer is not in use.

To use the feature, the monitor needs to be connected to a VESA DPMS compliant computer. There is a power management step the monitor takes as described below. The power management function, including any timer settings is configured by the operating system. Check your operating system manual for information on how this can be configured.

■ Power Management Mode

When the H-sync signal / V-sync signal / H and V sync signals from the computer are off, the monitor enters into Power Management Mode which reduces the power consumption to less than 0.5W. The screen becomes dark. From Power Management Mode, the image reappears in several seconds when either the keyboard or the mouse are touched again.

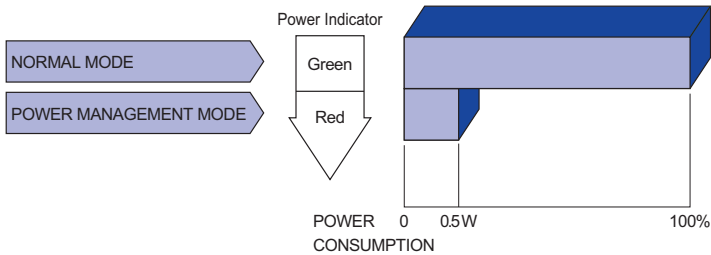

NOTE

- Even when using the power management mode, the monitor consumes electricity. Turn off the Power Switch whenever the monitor is not in use, during the night and weekends, to avoid unnecessary power consumption.
- It is possible that the video signal from the computer may be on while the H or V sync signal is missing. In this instance, the POWER MANAGEMENT feature may not work properly.

TROUBLE SHOOTING

If the monitor fails to operate correctly, please follow the steps below for a possible solution.

1. Perform the adjustments described in OPERATING THE MONITOR, depending on the problem you have. If the monitor does not get a picture, skip to 2.
2. Consult the following items if you cannot find an appropriate adjustment item in OPERATING THE MONITOR or if the problem persists.
3. If you are experiencing a problem which is not described below or you cannot correct the problem, discontinue using the monitor and contact your dealer or iiyama service center for further assistance.

Problem	Check
① The picture does not appear.	<input type="checkbox"/> The Power Cable is firmly seated in the socket. <input type="checkbox"/> The Power Switch is turned ON. <input type="checkbox"/> The AC socket is live. Please check with another piece of equipment. <input type="checkbox"/> If the blank screen saver is in active mode, touch the keyboard or the mouse. <input type="checkbox"/> Increase the Contrast and/or Brightness. <input type="checkbox"/> The computer is ON. <input type="checkbox"/> The Signal Cable is properly connected. <input type="checkbox"/> The signal timing of the computer is within the specification of the monitor. <input type="checkbox"/> If the monitor is in power management mode, touch the keyboard or the mouse.
② The screen is not synchronized.	<input type="checkbox"/> The Signal Cable is properly connected. <input type="checkbox"/> The signal timing of the computer is within the specification of the monitor. <input type="checkbox"/> The video output level of the computer is within the specification of the monitor.
③ The screen position is not in the center.	<input type="checkbox"/> The signal timing of the computer is within the specification of the monitor.
④ The screen is too bright or too dark.	<input type="checkbox"/> The video output level of the computer is within the specification of the monitor.
⑤ The screen is shaking.	<input type="checkbox"/> The power voltage is within the specification of the monitor. <input type="checkbox"/> The signal timing of the computer is within the specification of the monitor.
⑥ No sound.	<input type="checkbox"/> The audio equipment (computer etc.) is ON. <input type="checkbox"/> The Audio Cable is properly connected. <input type="checkbox"/> The Volume is turned up. <input type="checkbox"/> The Mute is OFF. <input type="checkbox"/> The audio output level of the audio equipment is within the specification of the monitor.
⑦ The sound is too loud or too quiet.	<input type="checkbox"/> The audio output level of the audio equipment is within the specification of the monitor.
⑧ A strange noise is heard.	<input type="checkbox"/> The Audio Cable is properly connected.
⑨ The touch screen shows no response.	<input type="checkbox"/> The USB Cable is firmly seated in the socket. <input type="checkbox"/> Touch screen driver software is installed.
⑩ The touch position does not deviate.	<input type="checkbox"/> The calibration function set up correctly.

RECYCLING INFORMATION

For better environment protection please don't dispose your monitor.
Please visit our web site: www.iiyama.com for monitor recycling.

ENGLISH

APPENDIX

Design and specifications are subject to change without prior notice.

SPECIFICATIONS : ProLite TH4265MS

Touch Screen	Technology	IR Touch 20points
	Light transmission	88%
	Hardness	7H
	Thickness	3mm
	Communication system	USB serial transfer
Size Category		42"
LCD Panel	Panel technology	AMVA3
	Size	Diagonal: 42" (106.7cm)
	Pixel pitch	0.4845mm H × 0.4845mm V
	Brightness	400cd/m ² (Typical: without Touch panel)
	Contrast ratio	3000 : 1 (Typical: without Touch panel)
	Viewable angle	Horizontal : 178 degrees, Vertical: 178 degrees (Typical)
	Response time	6.5ms (Gray to Gray)
Display Colors		Approx. 16.7M
Sync Frequency		Analog: Horizontal: 30.0-83.0kHz, Vertical: 50-76Hz Digital: Horizontal: 30.0-83.0kHz, Vertical: 50-76Hz
Maximum Resolution		1920 × 1080, 2.1 MegaPixels
Input Connector		VGA, HDMI×3
Input Video Connector		RCA
Input Audio Connector		mini jack, RCA (L/R)
Input Component Connector		RCA (Video/L/R)
LAN		RJ45
Serial Port		RS-232C In/Out
Plug & Play		VESA DDC2B™
Input Sync Signal		Separate sync: TTL, Positive or Negative
Input Video Signal		Analog: 0.7Vp-p (Standard), 75Ω, Positive Digital: HDMI
Input Audio Signal		0.5Vrms maximum
IR Extender Connector		IR In / Out
USB Connector		USB2.0×2 (Media Player)
Output Connector		HDMI
Output Video Connector		RCA
Headphone Connector		RCA(L/R)
Speakers		10W×2 (Stereo speakers)
Maximum Screen Size		930.24mm W × 523.26mm H / 36.6" W × 20.6" H
Power Source		100-240VAC, 50-60Hz, 1.8A
Power Consumption*		75W typical, Power management mode: 0.5W maximum Energy Efficiency Class: B

NOTE * USB peripherals / Audio equipment are not connected.

Dimensions / Net Weight	987.0 × 578.0 × 74.5mm / 38.9 × 22.8 × 2.9" (W×H×D) 24.6kg / 54.3lbs		
Environmental Considerations	Operating:	Temperature	0 to 40°C / 32 to 104°F
		Humidity	5 to 85% (No condensation)
	Storage:	Temperature	-20 to 60°C / 4 to 140°F
		Humidity	5 to 85% (No condensation)
Approvals	CB, CE, EAC, TÜV-Bauart		

SPECIFICATIONS : ProLite LH4265S

Size Category	42"	
LCD Panel	Panel technology	AMVA3
	Size	Diagonal: 42" (106.7cm)
	Pixel pitch	0.4845mm H × 0.4845mm V
	Brightness	400cd/m ² (Typical: without Touch panel)
	Contrast ratio	3000 : 1 (Typical: without Touch panel)
	Viewable angle	Horizontal : 178 degrees, Vertical: 178 degrees (Typical)
	Response time	6.5ms (Gray to Gray)
Display Colors	Approx.16.7M	
Sync Frequency	Analog: Horizontal: 30.0-83.0kHz, Vertical: 50-76Hz Digital: Horizontal: 30.0-83.0kHz, Vertical: 50-76Hz	
Maximum Resolution	1920 × 1080, 2.1 MegaPixels	
Input Connector	VGA, HDMI×3	
Input Video Connector	RCA	
Input Audio Connector	mini jack, RCA (L/R)	
Input Component Connector	RCA (Video/L/R)	
LAN	RJ45	
Serial Port	RS-232C In/Out	
Plug & Play	VESA DDC2B™	
Input Sync Signal	Separate sync: TTL, Positive or Negative	
Input Video Signal	Analog: 0.7Vp-p (Standard), 75Ω, Positive Digital: HDMI	
Input Audio Signal	0.5Vrms maximum	
IR Extender Connector	IR In / Out	
USB Connector	USB2.0×2 (Media Player)	
Output Connector	HDMI	
Output Video Connector	RCA	
Headphone Connector	RCA(L/R)	
Speakers	10W×2 (Stereo speakers)	
Maximum Screen Size	930.24mm W × 523.26mm H / 36.6" W × 20.6" H	
Power Source	100-240VAC, 50-60Hz, 1.8A	
Power Consumption*	72W typical, Power management mode: 0.5W maximum Energy Efficiency Class: B	
Dimensions / Net Weight	960.5 × 553.5 × 57.5mm / 37.8 × 21.8 × 2.3" (W×H×D) 18.4kg / 40.7lbs	
Environmental Considerations	Operating: Temperature 0 to 40°C / 32 to 104°F Humidity 5 to 85% (No condensation) Storage: Temperature -20 to 60°C / 4 to 140°F Humidity 5 to 85% (No condensation)	
Approvals	CB, CE, EAC, TÜV-Bauart	

NOTE * Audio equipment are not connected.

DIMENSIONS : ProLite TH4265MIS

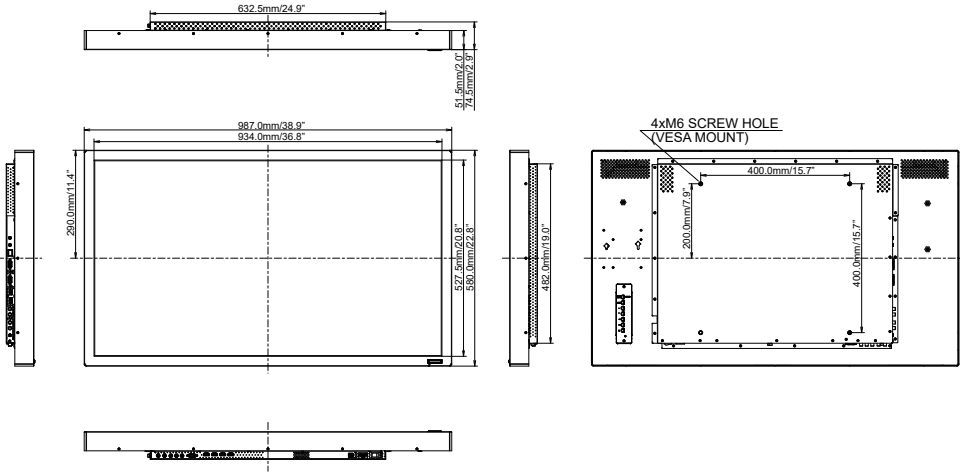

DIMENSIONS : ProLite LH4265S

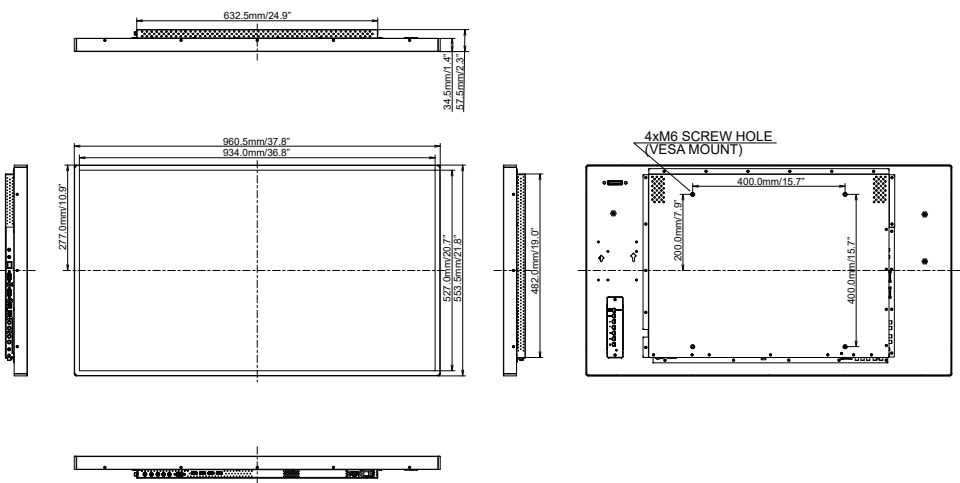

COMPLIANT TIMING

Timing		fH(kHz)	fV(Hz)	Dot clock (MHz)	VGA	HDMI	YPbPr	AV	
VESA	VGA 640x480	31.469	59.940	25.175	○	○			
		37.861	72.810	31.500	○	○			
	SVGA 800x600	37.500	75.000	31.500	○	○			
		35.156	56.000	36.000	○	○			
		37.879	60.320	40.000	○	○			
		48.076	72.000	50.000	○	○			
	XGA 1024x768	46.875	75.000	49.500	○	○			
		48.363	60.000	65.000	○	○			
		56.475	70.000	75.000	○	○			
	WXGA 1280x800	60.023	75.030	78.750	○	○			
		47.776	59.870	79.500	○	○			
		1280x768 RB	47.400	60.000	68.250	○	○		
		1280x768	60.060	75.000	78.800	○	○		
		SXGA 1280x1024	49.702	59.810	83.500	○			
			62.800	75.000	106.500	○			
63.981		60.020	108.000	○	○				
79.976		75.000	135.000	○					
1360x768		47.712	60.020	85.500	○	○			
1440x900		55.919	60.000	106.470	○				
FHD 1920x1080	67.500	60.000	148.500	○					
SD	NTSC-M	15.734	59.940	13.500				○	
	NTSC-J	15.734	59.940	13.500				○	
	PAL-BDGI	15.734	59.940	13.500				○	
	720x480i	60Hz	15.734	59.940	13.500		○		
	720x576i	50Hz	15.625	50.000	13.500		○		
	720x480p	60Hz	31.469	59.940	27.000		○		
HD	1280x720p	720x576p	50Hz	31.250	50.000	27.000		○	
		50Hz	37.500	50.000	74.250		○		
	1080i	60Hz	45.000	60.000	74.250		○		
		50Hz	28.125	50.000	74.250		○		
	1080p	60Hz	33.750	60.000	74.250		○		
		24Hz	27.000	24.000	74.250		○		
		25Hz	28.125	25.000	74.250		○		
		30Hz	33.750	30.000	74.250		○		
		50Hz	56.250	50.000	148.500		○	○	
		60Hz	67.500	60.000	148.500		○	○	
1440x576p	50Hz	31.250	50.000	27.000		○			
1440x480p	60Hz	31.250	60.000	27.027		○			

* ○ means supported the timing.