

# USER MANUAL

# *ProLite*

## LCD Monitor

ENGLISH

### *ProLite XCB3494WQSN*

Thank you very much for choosing the iiyama LCD monitor.

We recommend that you take a few minutes to read this comprehensive manual carefully before installing and switching on the monitor. Please keep this manual in a safe place for your future reference.



## Dear user, we congratulate you on the purchase of your iiyama LCD.

For details on warranty and locally used pixel policies that apply directly after installation of your product please check the iiyama website.

## To report a fault, please contact your local support centre found at <https://iiyama.com>

### Things to check before you call the iiyama information line

- | if the power cable is connected securely and turned on?
- | if the display has been turned on?
- | if the signal cable is connected securely and the correct input selected?
- | if the computer has been restarted with the display connected?
- | if the graphics card is correctly installed with the latest drivers possible?
- | if the correct native resolution has been selected via 'Display Properties'?
- | If the R/G/B signal configuration is correct?
- | if the displays On Screen Menu is shown?
- | if the correct brightness and contrast settings have been set?
- | if given display tolerances and compatibility have been considered?
- | if via the On Screen Menu you have performed a Factory Reset/Recall?

### Before reporting the screen defect, please prepare the following information/evidence:

- | model number \*
- | purchase receipt and serial number \*
- | name and address for collection
- | telephone/fax number, for availability during the day
- | convenient collection date (date, time)
- | short description of the defect

### Important Note:

If there is no fault found in the collected equipment after inspection, the transferring party shall incur charges for transport and administration.

If you have checked all of the above and there is still no picture, call our information line for assistance in your country.

### Feedback on health and safety issues

If you have any health and safety concerns or questions about the product (including when using the product), please contact iiyama support through our website. You can also contact us by calling +31 204460404. After receiving your feedback, we will ask the responsible unit to handle it as soon as possible and a dedicated person will get back to you. Your feedback will also be recorded and incorporated into our evaluation for improvements

\* see the identification plate on the back of the case.

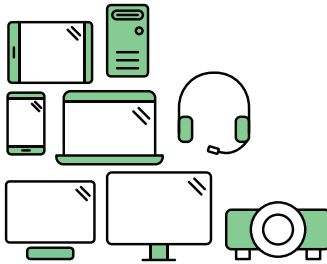

## Say hello to a more sustainable product

IT products are associated with a wide range of sustainability risks throughout their life cycle. Human rights violations are common in the factories. Harmful substances are used both in products and their manufacture. Products can often have a short lifespan because of poor ergonomics, low quality and when they are not able to be repaired or upgraded.

**This product is a better choice.** It meets all the criteria in TCO Certified, the world's most comprehensive sustainability certification for IT products. Thank you for making a responsible product choice, that help drive progress towards a more sustainable future!

Criteria in TCO Certified have a life-cycle perspective and balance environmental and social responsibility. Conformity is verified by independent and approved verifiers that specialize in IT products, social responsibility or other sustainability issues. Verification is done both before and after the certificate is issued, covering the entire validity period. The process also includes ensuring that corrective actions are implemented in all cases of factory non-conformities. And last but not least, to make sure that the certification and independent verification is accurate, both TCO Certified and the verifiers are reviewed regularly.

### Want to know more?

Read information about TCO Certified, full criteria documents, news and updates at [tcocertified.com](https://tcocertified.com). On the website you'll also find our Product Finder, which presents a complete, searchable listing of certified products.

## CE MARKING DECLARATION OF CONFORMITY

This LCD monitor complies with the requirements of the EC/EU Directive 2014/30/EU "EMC Directive", 2014/35/EU "Low Voltage Directive", 2009/125/EC "ErP Directive" and 2011/65/EU "RoHS Directive".

The electro-magnetic susceptibility has been chosen at a level that gives correct operation in residential areas, business and light industrial premises and small-scale enterprises, inside as well as outside of the buildings. All places of operation are characterised by their connection to the public low voltage power supply system.

IYAMA CORPORATION: Wijkemeerstraat 8, 2131 HA Hoofddorp, The Netherlands

Model No. : PL3494WQ



We recommend recycling of used product. Please contact your dealer or iiyama service center. Recycle information is obtained via the Internet, using the address:  
<https://iiyama.com>

You can access the Web page of different countries from there.

- We reserve the right to change specifications without notice.
- All trademarks used in this user manual are the property of their respective owners.
- Eprel registration number XCB3494WQSN-B5 A : 1952408

# TABLE OF CONTENTS

FOR YOUR SAFETY.....	1
SAFETY PRECAUTIONS.....	1
SPECIAL NOTES ON LCD MONITORS.....	3
CUSTOMER SERVICE.....	3
CLEANING.....	3
BEFORE YOU OPERATE THE MONITOR.....	4
FEATURES.....	4
CHECKING THE CONTENTS OF THE PACKAGE.....	4
USING ARM OR STAND.....	5
FITTING AND REMOVAL OF STAND.....	6
CONTROLS AND CONNECTORS.....	8
CONNECTING YOUR MONITOR.....	9
COMPUTER SETTING.....	11
ADJUSTING THE HEIGHT AND THE VIEWING ANGLE.....	11
OPERATING THE MONITOR.....	12
ADJUSTMENT MENU CONTENTS.....	13
STANDBY FEATURE.....	24
TROUBLE SHOOTING.....	25
RECYCLING INFORMATION.....	26
APPENDIX.....	27
SPECIFICATIONS : ProLite XCB3494WQSN-B5 A.....	27
DIMENSIONS.....	28
COMPLIANT TIMING.....	28

# FOR YOUR SAFETY

## SAFETY PRECAUTIONS

### WARNING

#### **STOP OPERATING THE MONITOR WHEN YOU SENSE TROUBLE**

If you notice any abnormal phenomena such as smoke, strange sounds or fumes, unplug the monitor and contact your dealer or iiyama service center immediately. Further use may be dangerous and can cause fire or electric shock.

#### **NEVER REMOVE THE CABINET**

High voltage circuits are inside the monitor. Removing the cabinet may expose you to the danger of fire or electric shock.

#### **DO NOT PUT ANY OBJECT INTO THE MONITOR**

Do not put any solid objects or liquids such as water into the monitor. In case of an accident, unplug your monitor immediately and contact your dealer or iiyama service center. Using the monitor with any object inside may cause fire, electric shock or damage.

#### **INSTALL THE MONITOR ON A FLAT, STABLE SURFACE**

The monitor may cause an injury if it falls or is dropped.

#### **DO NOT USE THE MONITOR NEAR WATER**

Do not use where water may be splashed or spilt onto the monitor as it may cause fire or electric shock.

#### **OPERATE UNDER THE SPECIFIED POWER SUPPLY**

Be sure to operate the monitor only with the specified power supply. Use of an incorrect voltage will cause malfunction and may cause fire or electric shock.

#### **PROTECT THE CABLES**

Do not pull or bend the power cable and signal cable. Do not place the monitor or any other heavy objects on the cables. If damaged, the cables may cause fire or electric shock.

#### **ADVERSE WEATHER CONDITIONS**

It is advisable not to operate the monitor during a heavy thunder storm as the continual breaks in power may cause malfunction. It is also advised not to touch the plug in these circumstances as it may cause electric shock.

## CAUTION

### INSTALLATION LOCATION

Do not install the monitor where sudden temperature changes may occur, or in humid, dusty or smoky areas as it may cause fire, electric shock or damage. You should also avoid areas where the sun shines directly on the monitor.

### DO NOT PLACE THE MONITOR IN A HAZARDOUS POSITION

The monitor may topple and cause injury if not suitably located. Please also ensure that you do not place any heavy objects on the monitor, and that all cables are routed such that children may not pull the cables and possibly cause injury.

### MAINTAIN GOOD VENTILATION

Ventilation slots are provided to keep the monitor from overheating. Covering the slots may cause fire. To allow adequate air circulation, place the monitor at least 10cm (or 4 inches) from any walls. When removing the tilt stand, the ventilation slots on the back side of the monitor can be blocked. This may overheat the monitor and may cause fire or damage. Make sure to allow enough ventilation when removing the tilt stand. Operating the monitor on its back, side, upside down or on a carpet or any other soft material may also cause damage.

### DISCONNECT THE CABLES WHEN YOU MOVE THE MONITOR

When you move the monitor, turn off the power switch, unplug the monitor and be sure the signal cable is disconnected. If you do not disconnect them, it may cause fire or electric shock.

### UNPLUG THE MONITOR

If the monitor is not in use for a long period of time it is recommended that it is left unplugged to avoid accidents.

### HOLD THE PLUG WHEN DISCONNECTING

To disconnect the power cable or signal cable, always pull it by the plug. Never pull on the cable itself as this may cause fire or electric shock.

### DO NOT TOUCH THE PLUG WITH WET HANDS

Pulling or inserting the plug with wet hands may cause electric shock.

### WHEN YOU INSTALL THE MONITOR ON YOUR COMPUTER

Be sure the computer is strong enough to hold the weight of the monitor, otherwise, you may damage your computer.

### CAREFUL! PROTECT YOUR HANDS AND FINGERS

Be careful not to hurt your fingers or hands when you change the height or the angle.

### REMARK FOR 24/7 USAGE

This product is not specifically designed for 24/7 usage in all environments.

### REMARK SPECIFIC TO DESKTOP USE

This product is designed for desktop use, not for digital signage (electronic signboard) applications such as ceiling hanging or wall mounting.

## OTHERS

### ERGONOMIC RECOMMENDATIONS

To eliminate eye fatigue, do not operate the monitor against a bright background or in a dark room. For optimal viewing comfort, the monitor should be just below eye level and 40-60cm (16-24 inches) away from your eyes. When using the monitor over a prolonged time, a ten minute break every hour is recommended as looking at the screen continuously can cause eye strain.

## SPECIAL NOTES ON LCD MONITORS

The following symptoms are normal with LCD monitors and do not indicate a problem.

- NOTE**
- When you first turn on the LCD monitor, the picture may not fit in the monitor area because of the type of computer that is used. In this case, adjust the picture position to the correct position.
  - You may find slightly uneven brightness on the screen depending on the desktop pattern you use.
  - Due to the nature of the LCD screen, an afterimage of the previous screen may remain after switching the image, when the same image is displayed for hours. In this case, the screen can be recovered slowly by changing the image or turning off the Power Switch for some hours.

## CUSTOMER SERVICE

- NOTE**
- If you have to return your unit for service and the original packaging has been discarded, please contact your dealer or iiyama service center for advice or replacement packaging.

## CLEANING

- WARNING**
- If you drop any materials or liquids such as water into the monitor when cleaning, unplug the power cable immediately and contact your dealer or iiyama service center.

- CAUTION**
- For safety reasons, turn off the power switch and unplug the monitor before you clean it.

- NOTE**
- To protect the LCD panel, do not scratch or rub the screen with a hard object.
  - Never use any of the following strong solvents. These will damage the cabinet and the LCD screen.

Thinner	Spray-type cleaner
Benzine	Wax
Abrasive cleaner	Acid or Alkaline solvent

- Touching the cabinet with any product made from rubber or plastic for a long time may cause degeneration or loss of paint on the cabinet.

**CABINET** Stains can be removed with a cloth lightly moistened with a mild detergent solvent. Then wipe the cabinet with a soft dry cloth.

**LCD** Periodic cleaning with a soft dry cloth is recommended.

**SCREEN** Don't use tissue paper etc. because these will damage the LCD screen.



# BEFORE YOU OPERATE THE MONITOR

## FEATURES

- ◆ Supports Resolutions up to 3440 × 1440
- ◆ High Contrast 4000:1 (Typical), Advanced Contrast Function Available, Brightness 350cd/m<sup>2</sup> (Typical)
- ◆ Moving Picture Response Time 0.4ms
- ◆ Supports AMD FreeSync™ Premium Technology
- ◆ Flicker - Free
- ◆ Blue Light Reducer
- ◆ Digital Character Smoothing
- ◆ USB Type-C / RJ45 - Connectors
- ◆ USB Power Delivery supports up to 65W
- ◆ 2 × 2W Stereo Speakers
- ◆ Ergonomic Design: TCO Certified
- ◆ Standby Feature
- ◆ VESA Mounting Standard (100mm×100mm) Compliant
- ◆ Keyhole for Security Lock

## CHECKING THE CONTENTS OF THE PACKAGE

The following accessories are included in your package. Check to see if they are enclosed with the monitor. If anything is missing or damaged, please contact your local iiyama dealer or regional iiyama office.

- Power Cable\*
- USB Cable (Type-C-C)
- Stand-Base with a screw
- Quick Start Guide
- HDMI Cable
- USB Cable (Type-A-B)
- Screwdriver
- DisplayPort Cable
- Stand-Neck
- Safety Guide

**CAUTION** \* All guarantees and warranties are void for any problems or damage caused by a power cable not supplied by iiyama.

An approved power cable greater or equal to H05VVVF, 3G, 0.75mm<sup>2</sup> must be used.

## USING ARM OR STAND

### CAUTION

- This product is designed for desktop use, not for digital signage (electronic signboard) applications such as ceiling hanging or wall mounting.
- Before installation, make sure the display arm or desk arm stand is strong enough to hold the necessary weight of the monitor and the mount.
- Panel angle adjustment range : 23° upward and 5° downward
- This product cannot be used with the monitor screen facing downward/upward.

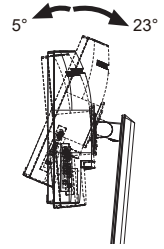

## [ DISPLAY ARM OR DESK ARM STAND ]

### CAUTION

- When you use with the display arm or desk arm stand, in consideration of thickness of the mounting stage, tighten the M4 Screws (4pcs) which "L" length is 10mm to fasten the monitor. Using the screw longer than this may cause electric shock or damage because it may contact with the electrical parts inside the monitor.

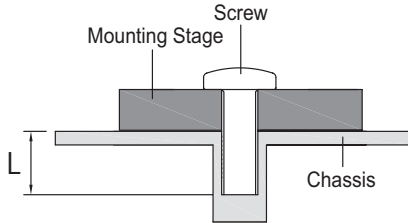

## [ LANDSCAPE MODE ]

This monitor can only be used in landscape. Do not rotate or operate the monitor in any other orientation than landscape.

### Available

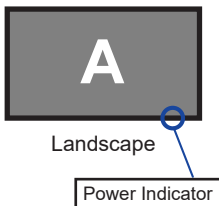

### Not Available

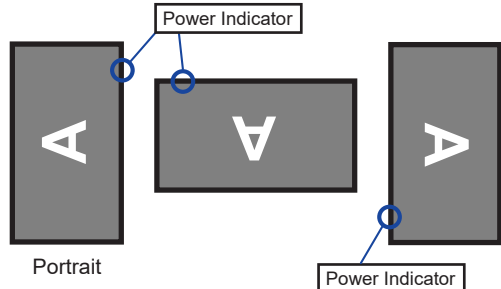

## FITTING AND REMOVAL OF STAND

### CAUTION

- Put the monitor on a stable surface. The monitor may cause injury or damage if it falls or is dropped.
- Do not give a strong impact to the monitor. It may cause damage.
- Unplug the monitor before removal or installation to avoid an electric shock or a damage.

### <Installation>

- ① As shown below, place all the contents taken out from the carton box on a flat surface with the monitor front face down.
- ② Take off the rear cushion, Stand-Neck and Stand-Base.

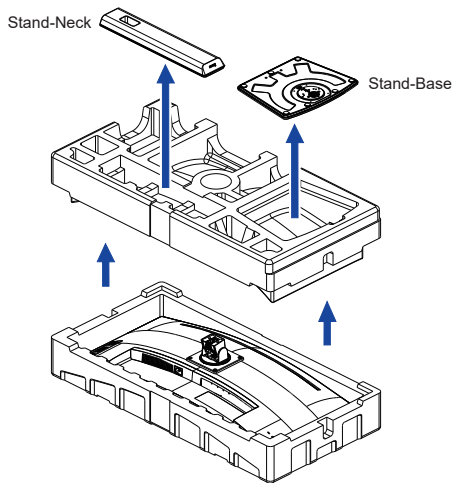

- ③ Install the Stand-Neck to the monitor and then tighten the 'thumb screw' with the provided screwdriver to secure them.

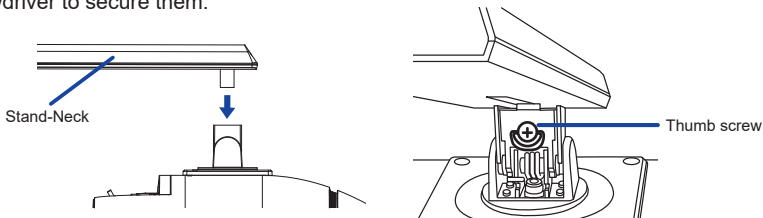

- ④ Install the Stand-Base to the Stand-Neck and then tighten the 'thumb screw' with the provided screwdriver to secure them.

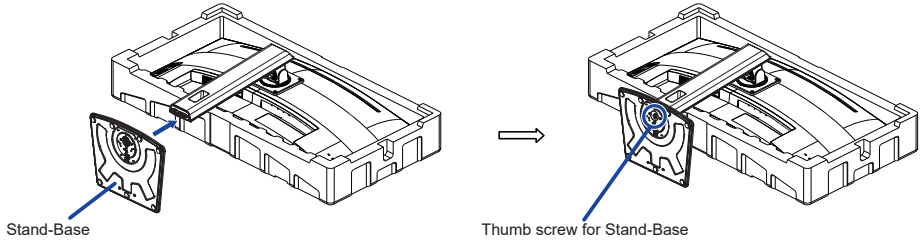

- ⑤ Stand the monitor and then remove the front cushion.

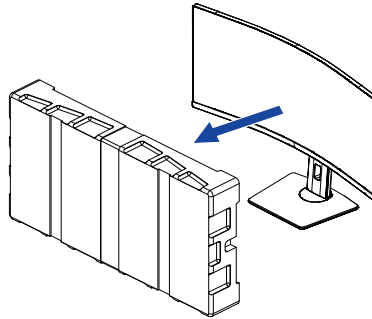

### <Removal>

- ① Put the front cushion on a flat surface and place the monitor with face down on it.
- ② Loosen the 'thumb screw' with the provided screwdriver to remove the Stand-Base from the Stand-Neck.
- ③ Loosen the 'thumb screw' with the provided screwdriver to remove the Stand-Neck from the monitor.

# CONTROLS AND CONNECTORS

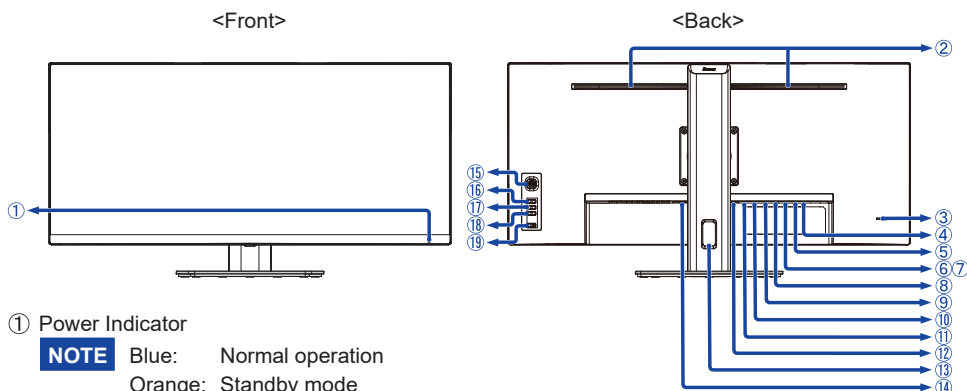

- ① Power Indicator

**NOTE** Blue: Normal operation  
Orange: Standby mode

- ② Speakers

- ③ Keyhole for Security Lock

**NOTE** You can fasten a security lock and cable to prevent the monitor from being removed without your permission.

- ④ Headphone Connector (  )

**NOTE** Proper operation of connected external devices other than headphones is not guaranteed.

- ⑤ USB Downstream Connector (  ) (USB3.2 Gen 1: 5Gbps, 5V, 900mA)

- ⑥ USB Downstream Connector (  ) (USB3.2 Gen 1: 5Gbps, 5V, 900mA)

- ⑦ USB Downstream Connector (  ) (USB3.2 Gen 1: 5Gbps, 5V, 900mA)

- ⑧ USB Upstream Connector (  )

- ⑨ LAN(RJ45) Connector (  )

- ⑩ USB Upstream Connector (USB-C) (USB3.2 Gen 1: 5Gbps, 20V, 3.25A)

- ⑪ DisplayPort Connector (DP)

- ⑫ HDMI Connector (HDMI)

- ⑬ Cable Hole

- ⑭ AC Connector ( ~ : Alternating current )

- ⑮ Navigation Button

Menu [Center]

Up [  ]

Down [  ]

Left / Eco [  ] \*1,2

Right / Blue Light Reducer [  ] \*1,2

- ⑯ Signal Select Button (INPUT) \*1

- ⑰ Volume + Button (VOL +) \*1

- ⑱ Volume – Button (VOL –) \*1

- ⑲ Power Button (  )

\*1 You can skip the Menu items and directly display an option setting screen or an adjustment scale.

\*2 Direction when viewing the screen from the front

## CONNECTING YOUR MONITOR

- ① Ensure that both the computer and the monitor are switched off.
  - ② Connect the computer to the monitor with the signal cable.
  - ③ Connect the computer to the monitor with the USB Cable (Type-A-B).
  - ④ Connect the computer to the monitor with the USB Cable (Type-C-C) when viewing images on your monitor through the USB Type-C Connector or when using the monitor's USB hub function.\*
  - ⑤ Connect the Power Cable to the monitor first and then to the power source.
  - ⑥ Turn on your monitor and computer.
- \* ● When charging connected device via USB Type-C Connector, check if the device is equipped with a USB Type-C Connector that supports charging function via USB PD (=Power Delivery).
- The USB power delivery is up to 65W. If the connected device required more than 65W for operation or for boot up (when the battery is drained), use the original power adapter that came with the device.
  - If a separately purchased USB Type-C Cable is used, make sure the cable is certified by USB-IF and is full-featured with power delivery and video / audio / data transfer functions.
  - If the monitor is in standby mode, it will not display a picture automatically in the following situations:
    1. First boot of the PC
    2. When the PC is resuming from standby modeTo display a picture, press the INPUT Button. This behaviour is normal. To prevent this behaviour, please access the OSD menu and set "USB Standby mode" to "OFF".
  - USB cable (Type-A-C) is not included with the monitor. If you use a USB cable (Type-A-C), please note that you can only transfer data.
  - Compatibility with all connected devices is not guaranteed due to different user environments.

### NOTE

- Make sure that the building installation has a circuit breaker of 120/240V, 20A (maximum).
- The signal cables used for connecting the computer and monitor may vary with the type of computer used. An incorrect connection may cause serious damage to both the monitor and the computer. The cable supplied with the monitor is for a standard connector. If a special cable is required please contact your local iiyama dealer or regional iiyama office.
- The Class I pluggable equipment Type A must be connected to protective earth.
- The socket-outlet shall be installed near the equipment and shall be easily accessible.
- Excessive sound pressure from ear-/headphones can cause hearing damage/hearing loss.

## [ Example of Connection ]

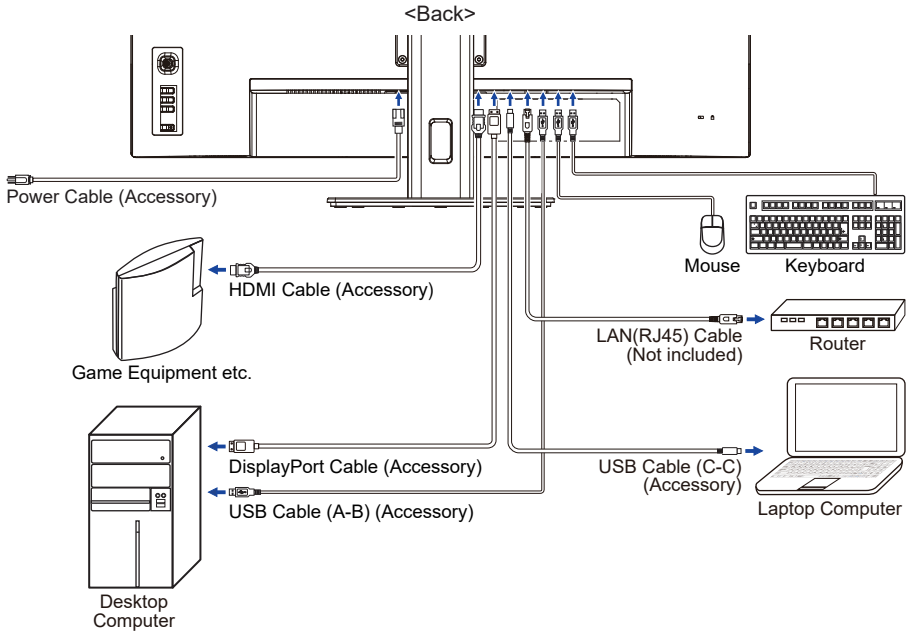

## [ Collect Cables ]

Put the cables through the Cable Hole to bundle them.

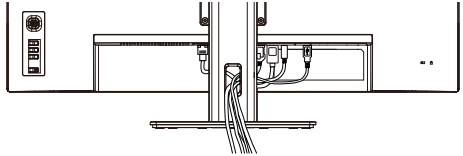

## COMPUTER SETTING

### ■ Signal Timing

Change to the desired signal timing listed on page 28: COMPLIANT TIMING.

## ADJUSTING THE HEIGHT AND THE VIEWING ANGLE

- For optimal viewing it is recommended to position yourself directly opposite to the full face of the monitor, then adjust the monitor's height and angle to your own preference.
- Hold the panel so that the monitor does not topple when you change the monitor's height or angle.
- You are able to adjust the monitor's height up to 150mm, angle up to 23° upward and 5° downward.

### NOTE

- Do not touch the LCD screen when you change the height or the angle. It may cause damage or break the LCD screen.
- Careful attention is required not to pinch your fingers or hands into the moving part of the stand when you change the height or the angle.
- Injury can occur if care is not taken to avoid finger contact with the displays base when adjusting the height.

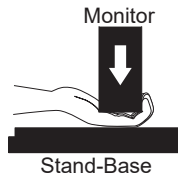
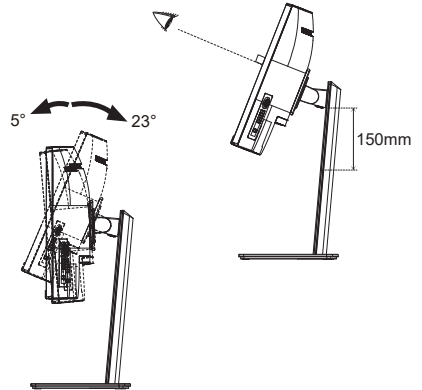



# OPERATING THE MONITOR

To create the best picture, your iiyama LCD monitor has been preset at the factory with the COMPLIANT TIMING shown on page 28. You are also able to adjust the picture by following the button operation shown below.

- ① Press the Navigation Button [Center] on the monitor to start the On Screen Display feature. There are additional Menu items which can be switched by the Navigation Button [↔/↔].



- ② Select the Menu item which contains the adjustment icon relating to the adjustment you want to make. Press the Navigation Button [Center]. Then, press the Navigation Button [↕/↕] to highlight the desired adjustment icon.
- ③ Press the Navigation Button [Center] again. Press the Navigation Button [↔/↔] to make the appropriate adjustment or setting.
- ④ Press the Navigation Button [Center] and then press the INPUT Button to leave the menu, and the settings you just made would be automatically saved.

For example, to correct for OSD vertical position, select Menu item of Setup Menu and then press the Navigation Button [Center]. Then, select OSD Vertical Position by pressing the Navigation Button [↕/↕].

An adjustment scale becomes active after you press the Navigation Button [Center]. Then, press the Navigation Button [↔/↔] to change the OSD vertical position settings. The OSD vertical position of the overall display should be changing accordingly while you are doing this.

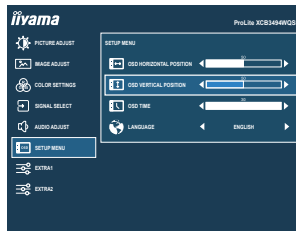







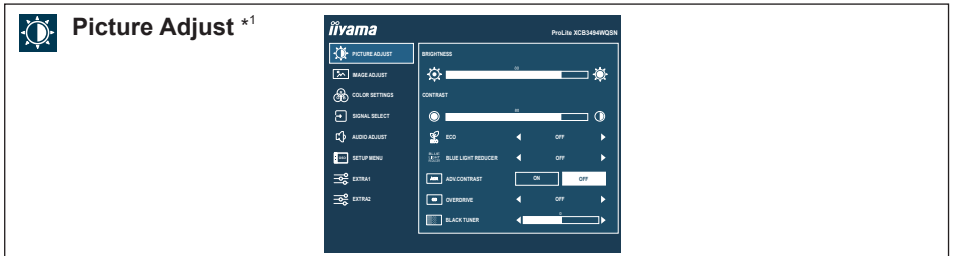

Press the Navigation Button [Center] and finally the INPUT Button to close the On Screen Display feature. All changes are saved in the memory.

## NOTE

- When Button operations are aborted during adjustment, On-Screen Display disappears when the time set for the OSD Time has passed. Also, the INPUT Button can be used to return previous menu and turn off the On Screen Display.
- Any changes are automatically saved in the memory when the On Screen Display disappears. Turning off the power should be avoided while using the Menu.

# ADJUSTMENT MENU CONTENTS



Adjustment Item	Problem / Option	Navigation Button
Brightness *2	Too dark Too bright	 
Contrast	Too dull Too intense	 
Eco <span style="float: right;"><b>Direct</b></span>	Off	Normal
	Mode1	Brightness of back-light is reduced.
	Mode2	Brightness of back-light is reduced more than Mode1.
	Mode3	Brightness of back-light is reduced more than Mode2.
Blue Light Reducer <span style="float: right;"><b>Direct</b></span>	Off	Normal
	Mode1	Blue light is reduced.
	Mode2	Blue light is reduced more than 1.
	Mode3	Blue light is reduced more than 2.
Adv. Contrast	On	Increased Contrast Ratio
	Off	Typical Contrast Ratio
Overdrive *3	Off / 1 / 2 / 3 / 4 / 5 It will improve the gray level response time of the LCD panel. A higher level results in a faster response time.	 
Black Tuner	From -5 to +5 You can adjust Dark shades.	 

**NOTE** Adv. Contrast adjusts brightness according to the image, and improve the contrast ratio during movie playing.

\*1 The availability of each item depends on which item is activated. See page 23 "Function Correlation Matrix" for more details.  
 \*2 Adjust the Brightness when you are using the monitor in a dark room and feel the screen is too bright.  
 \*3 When Overdrive is activated, some level of image retention will be caused.

## Direct



You can skip the Menu items and directly display an option setting screen by using the following button operations.

- Eco: Press the Navigation Button Left [↶] when the Menu is not displayed.
- Blue Light Reducer: Press the Navigation Button Right [↷] when the Menu is not displayed.

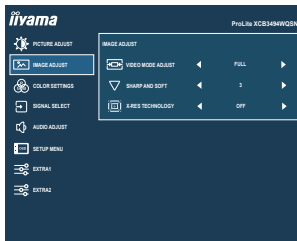

## Image Adjust



Adjustment Item	Problem / Option		Navigation Button
Video Mode Adjust * <sup>1</sup>	Full	Expansion display	
	Aspect	Expansion display of Aspect	
	Dot by Dot * <sup>2</sup>	Display the picture dot by dot.	
Sharp and Soft	1 2 3 4 5 6	You can change the picture quality from 1 to 6 (sharp to soft). Press Right [↵] to change the picture quality in numerical order. Press Left [⇐] to change the picture quality in reverse numerical order.	 
X-Res Technology * <sup>3</sup>	Off	Normal	
	Soft	Enhance the picture edge.	
	Middle	Enhance the picture edge more than the Soft option.	
	Hard	Enhance the picture edge more than the Middle option.	

\*<sup>1</sup> It can display in the center of the screen with a 4:3, 5:4 or 16:10 aspect ratio when input video resolution is 4:3, 5:4 or 16:10.

\*<sup>2</sup> The availability of each item depends on which item is activated. See page 23 "Function Correlation Matrix" for more details.

\*<sup>3</sup> Disabled when HDR is active.



# Color Settings \*

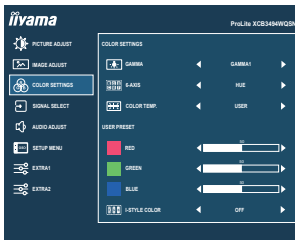

ENGLISH

Adjustment Item	Problem / Option		Navigation Button	
Gamma	Gamma1	Normal		
	Gamma2	Dark		
	Gamma3	High contrast		
6-Axis	Hue	Red	Too weak Too strong	
		Yellow		
		Green		
		Cyan		
		Blue		
	Saturation	Red	Too weak Too strong	
		Yellow		
		Green		
		Cyan		
		Blue		
Color Temp.	User	Red	Too weak Too strong	
		Green		
		Blue		
	sRGB	sRGB		
	Warm	Warm color		
	Normal	Normal color		
	Cool	Cool color		
	i-Style Color	Off	Return to a state set by color adjustment except i-Style Color.	
Standard		For general windows environment and monitor default setting.		
Text		For text editing and viewing in a word processing environment.		
Internet		For internet environment.		
Game		For PC game environment.		
Sports		For sport environment.		

### NOTE

- sRGB is an international standard which defines and unifies the difference of color appearance between equipment.
- Contrast, Eco, Blue Light Reducer, Adv. Contrast, Black Tuner, Gamma, 6-Axis and i-Style Color are locked during sRGB mode and cannot be adjusted.

\* The availability of each item depends on which item is activated. See page 23 "Function Correlation Matrix" for more details.



Adjustment Item	Problem / Option	
Signal Select <span style="background-color: #0056b3; color: white; padding: 2px 5px; border-radius: 3px;">Direct</span>	AUTO	Select the signal input automatically.
	HDMI	Select the Digital (HDMI) input.
	DP	Select the Digital (DisplayPort) input.
	USB-C	Select the Digital (USB Type-C) input.

**NOTE** At selected the AUTO, it will automatically be selected when just one source is available. If there are more input sources available and you select one of them, the AUTO option is not available.  
 If multiple inputs are connected, the monitor may not recover the last one used after turning it off and on again.  
 It is only possible when you set a specific source.



## Direct

You can skip the Menu items and directly display an option setting screen by using the following button operations.

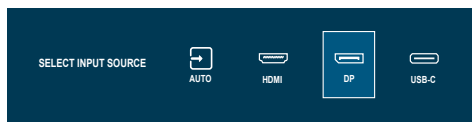
- Signal Select: Press the INPUT Button when the Menu is not displayed, it shows following Menu.

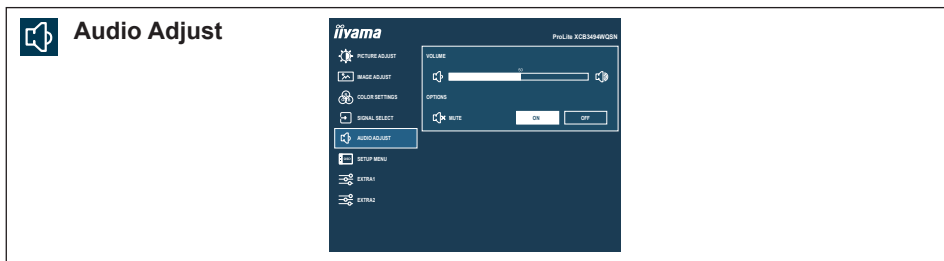



Adjustment Item	Problem / Option		Navigation Button
Volume <span style="float: right;"><b>Direct</b></span>	Too soft Too loud		 
Mute	On	Turn off the sound temporarily.	
	Off	Return the sound volume to the previous level.	

### Direct









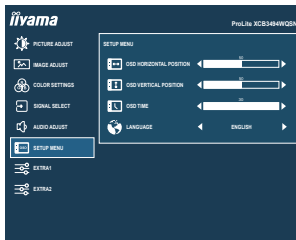



You can skip the Menu items and directly display an adjustment scale by using the following button operations.

- Volume: Press the VOL + / VOL – Buttons when the Menu is not displayed.





## Setup Menu



Adjustment Item	Problem / Option	Navigation Button		
OSD Horizontal Position	OSD is too left OSD is too right	   		
OSD Vertical Position	OSD is too low OSD is too high	   		
OSD Time	You can set the OSD display duration time between 5 and 30 seconds.	   		
Language	English	English	Nederlands	Dutch
	Deutsch	German	Polski	Polish
	Español	Spanish	Português	Portuguese
	Français	French	Русский	Russian
	Italiano	Italian	Česky	Czech
	日本語	Japanese		

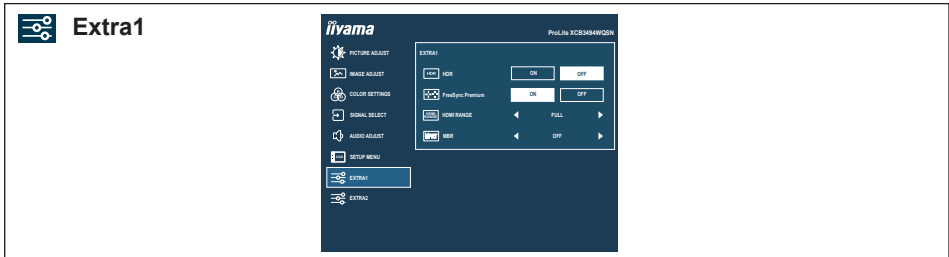



Adjustment Item	Problem / Option		Navigation Button
HDR * <sup>1</sup>	On	For HDR (High Dynamic Range) signal	
	Off	For normal signal	
FreeSync Premium * <sup>1</sup>	On	Enable the FreeSync function.	
	Off	The FreeSync function is turned off.	
HDMI Range	Full	For full-range color scale signal.	
	Limited	For limited color scale signal.	
	Auto	Select the HDMI Range automatically.	
MBR * <sup>1,2</sup>	Off / 1 / 2 / 3 / 4 / 5 / 6 / 7 Improve the moving picture response time of the LCD panel.		

\*<sup>1</sup> The availability of each item depends on which item is activated. See page 23 "Function Correlation Matrix" for more details.

\*<sup>2</sup> MBR is available only when the refresh rate is 75Hz or more.



# Extra2

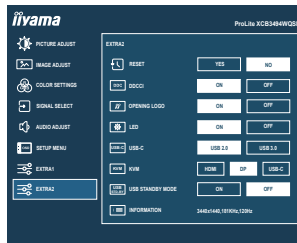

Adjustment Item	Problem / Option		
Reset	Yes	Factory-preset data is restored.	
	No	Return to Menu.	
DDCCI	On	DDC/CI is On.	
	Off	DDC/CI is Off.	
Opening Logo	On	Opening Logo is On.	
	Off	Opening Logo is Off.	
LED	On	The Power Indicator is turned On.	
	Off	The Power Indicator is turned Off.	
<p><b>NOTE</b> Turn Off the Power Indicator when you are bothered by the light.</p>			
USB-C	USB 2.0	Select the data transfer speed when connecting via USB Type-C.	
	USB 3.0		
<p><b>NOTE</b> When USB 3.0 is selected on USB Type-C input, 3440 × 1440 resolution at 100Hz / 120Hz cannot be supported.</p>			
KVM	HDMI	USB-B	When two or three computers are connected to the monitor, you can link the input source with the USB upstream connector.
		USB-C	
	DP	USB-B	
		USB-C	
USB-C	USB-B		
USB Stanby mode	On	The USB hub enters into the standby mode in synchronization with the monitor.	
	Off	The USB hub remains activated if the monitor enters into the standby mode.	
Information	<p>Displays information regarding the current input signal coming from the graphic card in your computer.</p> <p><b>NOTE</b> See your graphic card user guide for more information about changing the resolution and refresh.</p>		

● **Lock Mode:**

**<OSD Menu>**

If you turn on the monitor with pressing the Navigation Button [Center] while the monitor is off, the OSD Menu operations will be locked / unlocked.

**<Power Button / OSD Menu>**

If you keep pressing the Navigation Button [Center] for 10 seconds when the Menu is not displayed, the Power Button / OSD Menu operations will be locked / unlocked.

## ■ Function Correlation Matrix

Selected item		Picture Adjust						Image Adjust				Color Settings						Extra1			
		Brightness	Contrast	Eco	Blue Light Reducer	Adv. Contrast	Overdrive	Black Tuner	Video Mode Adjust	Dot by Dot	Gamma	6-Axis	User sRGB	Color Temp.	Warm	Normal	Cool	i-Style Color	HDR	Free Sync Premium	MBR
Active item	Eco	-	✓	/	-	-	✓	✓	✓	✓	✓	✓	✓	✓	-	-	-	✓	-	✓	-
	Blue Light Reducer	✓	✓	-	/	-	✓	✓	✓	✓	✓	-	-	-	-	-	-	-	-	✓	-
Image Adjust	Adv. Contrast	-	-	-	-	✓	✓	✓	/	✓	✓	✓	✓	✓	✓	✓	✓	✓	✓	-	✓
	Video Mode Adjust	✓	✓	✓	✓	✓	✓	✓	✓	✓	✓	✓	✓	✓	✓	✓	✓	✓	✓	✓	✓
Color Settings	Color Temp. sRGB	-	-	-	-	-	-	-	✓	-	-	✓	✓	✓	✓	✓	✓	✓	✓	✓	-
	i-Style Color	-	-	-	-	-	-	-	✓	-	-	✓	✓	✓	✓	✓	✓	✓	✓	✓	-
Extra1	HDR	-	-	-	-	-	✓	✓	✓	✓	✓	✓	✓	✓	✓	✓	✓	✓	✓	✓	-
	FreeSync Premium	✓	✓	✓	✓	✓	✓	✓	✓	✓	✓	✓	✓	✓	✓	✓	✓	✓	✓	✓	-
	MBR	-	✓	-	-	-	-	✓	✓	✓	✓	✓	✓	✓	✓	✓	✓	✓	✓	✓	-

✓ : Available

- : Not available

## STANDBY FEATURE

This product features the standby function. When activated, it automatically reduces unnecessary power consumption of the monitor when your computer is not in use.

There is a standby step the monitor takes as described below. The standby function, including any timer settings is configured by the operating system. Check your operating system manual for information on how this can be configured.

### ■ Standby Mode

When the video signal from the computer is off, the monitor enters into Standby Mode which reduces the power consumption to 0.5W or less\*. The screen becomes dark, and the power indicator turns to orange. From Standby Mode, the image reappears in several seconds when either the keyboard or the mouse are touched again.

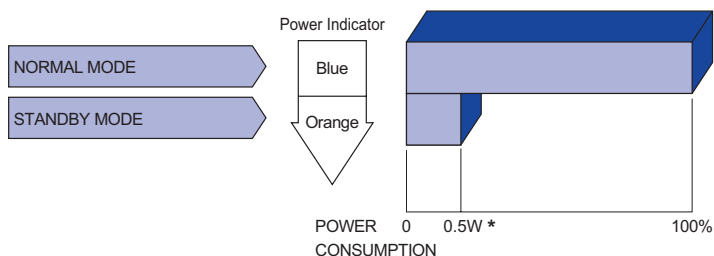

\* When "USB Stanby mode" in the "Extra2" menu is On.

# TROUBLE SHOOTING

If the monitor fails to operate correctly, please follow the steps below for a possible solution.

1. Perform the adjustments described in OPERATING THE MONITOR, depending on the problem you have. If the monitor does not get a picture, skip to 2.
2. Consult the following items if you cannot find an appropriate adjustment item in OPERATING THE MONITOR or if the problem persists.
3. If you are experiencing a problem which is not described below or you cannot correct the problem, discontinue using the monitor and contact your dealer or iiyama service center for further assistance.

<b>Problem</b>	<b>Check</b>
① The picture does not appear.  (Power indicator does not light up.)  (Power indicator is blue.)  (Power indicator is orange.)	<input type="checkbox"/> The Power Cable is firmly seated in the socket. <input type="checkbox"/> The Power Switch is turned ON. <input type="checkbox"/> The AC socket is live. Please check with another piece of equipment.  <input type="checkbox"/> If the blank screen saver is in active mode, touch the keyboard or the mouse. <input type="checkbox"/> Increase the Contrast and/or Brightness. <input type="checkbox"/> The computer is ON. <input type="checkbox"/> The Signal Cable is properly connected. <input type="checkbox"/> The signal timing of the computer is within the specification of the monitor.  <input type="checkbox"/> If the monitor is in standby mode, touch the keyboard or the mouse. <input type="checkbox"/> The computer is ON. <input type="checkbox"/> The Signal Cable is properly connected. <input type="checkbox"/> The signal timing of the computer is within the specification of the monitor.
② The screen is not synchronized.	<input type="checkbox"/> The Signal Cable is properly connected. <input type="checkbox"/> The signal timing of the computer is within the specification of the monitor.
③ The screen position is not in the center.	<input type="checkbox"/> The signal timing of the computer is within the specification of the monitor.
④ The screen is too bright or too dark.	<input type="checkbox"/> The video output level of the computer is within the specification of the monitor.

## Problem

## Check

- |                                       |  |
|---------------------------------------|--|
| ⑤ The screen is shaking.              | <input type="checkbox"/> The power voltage is within the specification of the monitor.                             |
|                                       | <input type="checkbox"/> The signal timing of the computer is within the specification of the monitor.             |
| ⑥ No sound.                           | <input type="checkbox"/> The audio equipment (computer etc.) is ON.  |
|                                       | <input type="checkbox"/> The Volume is turned up.  |
|                                       | <input type="checkbox"/> The Mute is OFF.  |
|                                       | <input type="checkbox"/> The audio output level of the audio equipment is within the specification of the monitor. |
| ⑦ The sound is too loud or too quiet. | <input type="checkbox"/> The audio output level of the audio equipment is within the specification of the monitor. |

## RECYCLING INFORMATION

For better environment protection please don't dispose your monitor.  
Please visit our web site: <https://iiyama.com> for monitor recycling.

# APPENDIX

Design and specifications are subject to change without prior notice.

## SPECIFICATIONS : ProLite XCB3494WQSN-B5 A

Size Category	34"	
LCD Panel	Panel technology	VA
	Size	Diagonal: 34" (86.4cm)
	Curvature	1500R
	Pixel pitch	0.232mm H × 0.232mm V
	Brightness	350cd/m <sup>2</sup> (Typical), 155cd/m <sup>2</sup> (Default / Energy Saving)
	Contrast ratio	4000 : 1 (Typical), Advanced Contrast Function Available
	Viewable angle	Right / Left: 89° each, Up / Down: 89° each (Typical)
	MPRT	0.4ms
Display Colors	16,777,216	
Sync Frequency	HDMI (FreeSync: Off): Horizontal: 30.0-185.0kHz Vertical: 30-120Hz (2560 × 1440 or less) 30-100Hz (3440 × 1440) HDMI (FreeSync: On): Horizontal: 30.0-185.0kHz Vertical: 48-120Hz (2560 × 1440 or less) 48-100Hz (3440 × 1440) DisplayPort / USB Type-C: Horizontal: 30.0-185.0kHz Vertical: 48-120Hz	
Native Resolution	3440 × 1440, 4.9 MegaPixels	
Supported max. resolution	HDMI: 3440 × 1440 100Hz 2560 × 1440 120Hz DisplayPort / USB Type-C: 3440 × 1440 120Hz	
Input Connector	HDMI, DisplayPort, USB Type-B, USB Type-C (Alt Mode)	
Input Video Signal	HDMI, DisplayPort, USB Type-C (Alt Mode)	
USB Standard	USB3.2 Gen 1 (5Gbps, DC5V, 900mA), USB Power Delivery (65W)	
Number of USB Ports	2 Upstream: Type-B, Type-C	
Connector shape	3 Downstream: Type-A	
LAN Port	RJ45	
Headphone Connector* <sup>1</sup>	ø 3.5mm mini jack (Stereo)	
Speakers	2W × 2 (Stereo speakers)	
Maximum Screen Size	797.22mm W × 333.72mm H / 31.4" W × 13.1" H	
Power Source	100-240VAC, 50/60Hz, 2.0A	
Power Consumption* <sup>2</sup>	45W (Typical), 31W (Default / Energy Saving) Standby mode: 0.5W maximum, Off mode: 0.3W maximum	
Dimensions* <sup>3</sup> , Net Weight	809.5 × 431.0 - 581.0 × 245.5(239.5)mm / 31.9 × 17.0 - 22.9 × 9.7(9.4)" (W×H×D), 9.3kg / 20.5lbs	
Height Adjustment Range	150mm	
Tilt Angle	Upward: 23 degrees, Downward: 5 degrees	
Environmental Considerations	Operating: Temperature 5 to 35°C / 41 to 95°F Humidity 10 to 80% (No condensation) Storage: Temperature -20 to 60°C / -4 to 140°F Humidity 10 to 90% (No condensation)	
Approvals	TCO Certified, CE, UKCA, TÜV-Bauart, EAC, VCCI, PSE	

### NOTE

\*<sup>1</sup> Proper operation of connected external devices other than headphones is not guaranteed.

\*<sup>2</sup> When "USB Stanby mode" in the "Extra2" menu is On.

\*<sup>3</sup> ( ) : Depth of the Stand-Base



## DIMENSIONS

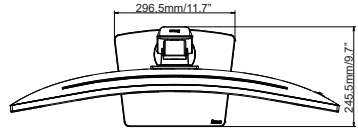
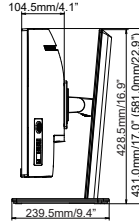
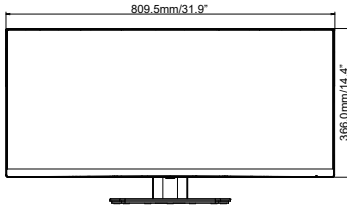

( ) : Maximum adjustment range

## COMPLIANT TIMING

Video Mode	Horizontal Frequency	Vertical Frequency	Dot Clock
800 × 600	37.879kHz	60.317Hz	40.000MHz
	46.875kHz	75.000Hz	49.500MHz
1024 × 768	48.363kHz	60.004Hz	65.000MHz
	60.023kHz	75.029Hz	78.750MHz
1280 × 1024	63.981kHz	60.020Hz	108.000MHz
	79.976kHz	75.025Hz	135.000MHz
1920 × 1080	67.500kHz	60.000Hz	148.500MHz
	112.500kHz	100.000Hz	297.000MHz
	135.000kHz	120.000Hz	297.000MHz
2560 × 1440	88.860kHz	60.000Hz	241.699MHz
	183.000kHz	120.000Hz	497.760MHz
3440 × 1440	43.830kHz	30.000Hz	154.281MHz
	88.860kHz	60.000Hz	319.896MHz
	151.000kHz	100.000Hz	543.600MHz
	181.200kHz	120.000Hz	652.320MHz

**NOTE** \*1 Available for HDMI input only.

\*2 Available for DisplayPort and USB Type-C inputs only.

\*3 In case of USB Type-C input, available only when "USB-C" in the "Extra2" menu is set to USB 2.0.

\*4 The source graphic card must be capable of supporting 3440 × 1440 resolution at 60Hz / 100Hz / 120Hz.

Console	1080p (1920×1080)	1440p (2560×1440)	2160p (3840×2160)
PS5	60 / 120Hz	60 / 120Hz	—
Xbox Series X/S	60 / 120Hz	120Hz	—