

USER MANUAL

G-MASTER

LCD Monitor

ENGLISH

G-MASTER G4380UHSU

Thank you very much for choosing the iiyama LCD monitor.

We recommend that you take a few minutes to read carefully through this brief but comprehensive manual before installing and switching on the monitor. Please keep this manual in a safe place for your future reference.



Dear user, we congratulate you on the purchase of your iiyama LCD.

For details on warranty and locally used pixel policies that apply directly after installation of your product please check the iiyama website.

To report a fault, please contact your local support centre found at <https://iiyama.com>

Things to check before you call the iiyama information line

- | if the power cable is connected securely and turned on?
- | if the display has been turned on?
- | if the signal cable is connected securely and the correct input selected?
- | if the computer has been restarted with the display connected?
- | if the graphics card is correctly installed with the latest drivers possible?
- | if the correct native resolution has been selected via 'Display Properties'?
- | If the R/G/B signal configuration is correct?
- | if the displays On Screen Menu is shown?
- | if the correct brightness and contrast settings have been set?
- | if given display tolerances and compatibility have been considered?
- | if via the On Screen Menu you have performed a Factory Reset/Recall?

Before reporting the screen defect, please prepare the following information/evidence:

- | model number *
- | purchase receipt and serial number *
- | name and address for collection
- | telephone/fax number, for availability during the day
- | convenient collection date (date, time)
- | short description of the defect

Important Note:

If there is no fault found in the collected equipment after inspection, the transferring party shall incur charges for transport and administration.

If you have checked all of the above and there is still no picture, call our information line for assistance in your country.

Feedback on health and safety issues

If you have any health and safety concerns or questions about the product (including when using the product), please contact iiyama support through our website. You can also contact us by calling +31 204460404. After receiving your feedback, we will ask the responsible unit to handle it as soon as possible and a dedicated person will get back to you. Your feedback will also be recorded and incorporated into our evaluation for improvements

* see the identification plate on the back of the case.

CE MARKING DECLARATION OF CONFORMITY

This LCD monitor complies with the requirements of the EC/EU Directive 2014/30/EU "EMC Directive", 2014/35/EU "Low Voltage Directive", 2009/125/EC "ErP Directive" and 2011/65/EU "RoHS Directive".

The electro-magnetic susceptibility has been chosen at a level that gives correct operation in residential areas, business and light industrial premises and small-scale enterprises, inside as well as outside of the buildings. All places of operation are characterised by their connection to the public low voltage power supply system.

IYAMA CORPORATION: Wijkmeerstraat 8, 2131 HA Hoofddorp, The Netherlands

Model No. : PL4380UH



Please familiarize yourself with the local regulations regarding the separate collection of electrical and electronic products. It is important to follow these guidelines and avoid disposing of old products with regular household waste. Proper disposal helps prevent potential negative impacts on the environment and human health.

This product contains batteries that are subject to the European Regulation (EU) 2023/1542, which prohibits disposal with regular household waste. For more information, please visit our recycling page at https://iiyama.com/gl_en/support/#recycling



We recommend recycling of used product. Please contact your dealer or iiyama service center. Recycle information is obtained via the Internet, using the address: <https://iiyama.com>

You can access the Web page of different countries from there.

- We reserve the right to change specifications without notice.
- All trademarks used in this user manual are the property of their respective owners.
- Eprel registration number G4380UHSU-B1 A : 1237811

TABLE OF CONTENTS

FOR YOUR SAFETY.....	1
SAFETY PRECAUTIONS.....	1
SPECIAL NOTES ON LCD MONITORS.....	3
CUSTOMER SERVICE.....	3
CLEANING.....	3
BEFORE YOU OPERATE THE MONITOR.....	4
FEATURES.....	4
CHECKING THE CONTENTS OF THE PACKAGE.....	4
INSTALLATION.....	5
FITTING AND REMOVAL OF BASE.....	6
CONTROLS AND CONNECTORS.....	7
FUNCTIONS OF THE REMOTE CONTROL.....	8
PREPARING THE REMOTE CONTROL.....	9
BASIC OPERATION.....	10
CONNECTING YOUR MONITOR.....	13
COMPUTER SETTING.....	14
ADJUSTING THE VIEWING ANGLE.....	14
OPERATING THE MONITOR.....	15
ADJUSTMENT MENU CONTENTS.....	17
STANDBY FEATURE.....	30
TROUBLE SHOOTING.....	31
RECYCLING INFORMATION.....	32
APPENDIX.....	33
SPECIFICATIONS : G-MASTER G4380UHSU-B1 A.....	33
DIMENSIONS.....	34
COMPLIANT TIMING.....	34

FOR YOUR SAFETY

SAFETY PRECAUTIONS

WARNING

STOP OPERATING THE MONITOR WHEN YOU SENSE TROUBLE

If you notice any abnormal phenomena such as smoke, strange sounds or fumes, unplug the monitor and contact your dealer or iiyama service center immediately. Further use may be dangerous and can cause fire or electric shock.

NEVER REMOVE THE CABINET

High voltage circuits are inside the monitor. Removing the cabinet may expose you to the danger of fire or electric shock.

DO NOT PUT ANY OBJECT INTO THE MONITOR

Do not put any solid objects or liquids such as water into the monitor. In case of an accident, unplug your monitor immediately and contact your dealer or iiyama service center. Using the monitor with any object inside may cause fire, electric shock or damage.

INSTALL THE MONITOR ON A FLAT, STABLE SURFACE

The monitor may cause an injury if it falls or is dropped.

DO NOT USE THE MONITOR NEAR WATER

Do not use where water may be splashed or spilt onto the monitor as it may cause fire or electric shock.

OPERATE UNDER THE SPECIFIED POWER SUPPLY

Be sure to operate the monitor only with the specified power supply. Use of an incorrect voltage will cause malfunction and may cause fire or electric shock.

PROTECT THE CABLES

Do not pull or bend the power cable and signal cable. Do not place the monitor or any other heavy objects on the cables. If damaged, the cables may cause fire or electric shock.

ADVERSE WEATHER CONDITIONS

It is advisable not to operate the monitor during a heavy thunder storm as the continual breaks in power may cause malfunction. It is also advised not to touch the plug in these circumstances as it may cause electric shock.

CAUTION

INSTALLATION LOCATION

Do not install the monitor where sudden temperature changes may occur, or in humid, dusty or smoky areas as it may cause fire, electric shock or damage. You should also avoid areas where the sun shines directly on the monitor.

DO NOT PLACE THE MONITOR IN A HAZARDOUS POSITION

The monitor may topple and cause injury if not suitably located. Please also ensure that you do not place any heavy objects on the monitor, and that all cables are routed such that children may not pull the cables and possibly cause injury.

MAINTAIN GOOD VENTILATION

Ventilation slots are provided to keep the monitor from overheating. Covering the slots may cause fire. To allow adequate air circulation, place the monitor at least 10cm (or 4 inches) from any walls. When removing the tilt stand, the ventilation slots on the back side of the monitor can be blocked. This may overheat the monitor and may cause fire or damage. Make sure to allow enough ventilation when removing the tilt stand. Operating the monitor on its back, side, upside down or on a carpet or any other soft material may also cause damage.

DISCONNECT THE CABLES WHEN YOU MOVE THE MONITOR

When you move the monitor, turn off the power switch, unplug the monitor and be sure the signal cable is disconnected. If you do not disconnect them, it may cause fire or electric shock.

UNPLUG THE MONITOR

If the monitor is not in use for a long period of time it is recommended that it is left unplugged to avoid accidents.

HOLD THE PLUG WHEN DISCONNECTING

To disconnect the power cable or signal cable, always pull it by the plug. Never pull on the cable itself as this may cause fire or electric shock.

DO NOT TOUCH THE PLUG WITH WET HANDS

Pulling or inserting the plug with wet hands may cause electric shock.

WHEN YOU INSTALL THE MONITOR ON YOUR COMPUTER

Be sure the computer is strong enough to hold the weight of the monitor, otherwise, you may damage your computer.

CAREFUL! PROTECT YOUR HANDS AND FINGERS

Be careful not to hurt your fingers or hands when you change the angle.

REMARK FOR 24/7 USAGE

This product is not specifically designed for 24/7 usage in all environments.

FOR SINGLE USERS

This product is primarily intended for close viewing by a single user.

OTHERS

ERGONOMIC RECOMMENDATIONS

To eliminate eye fatigue, do not operate the monitor against a bright background or in a dark room. For optimal viewing comfort, the monitor should be just below eye level and 40-60 cm (16-24 inches) away from your eyes. When using the monitor over a prolonged time, a ten minute break every hour is recommended as looking at the screen continuously can cause eye strain.

SPECIAL NOTES ON LCD MONITORS

The following symptoms are normal with LCD monitors and do not indicate a problem.

- NOTE**
- When you first turn on the LCD monitor, the picture may not fit in the monitor area because of the type of computer that is used. In this case, adjust the picture position to the correct position.
 - You may find slightly uneven brightness on the screen depending on the desktop pattern you use.
 - Due to the nature of the LCD screen, an afterimage of the previous screen may remain after switching the image, when the same image is displayed for hours. In this case, the screen can be recovered slowly by changing the image or turning off the Power Switch for some hours.

CUSTOMER SERVICE

- NOTE**
- If you have to return your unit for service and the original packaging has been discarded, please contact your dealer or iiyama service center for advice or replacement packaging.

CLEANING

- WARNING**
- If you drop any materials or liquids such as water into the monitor when cleaning, unplug the power cable immediately and contact your dealer or iiyama service center.

- CAUTION**
- For safety reasons, turn off the power switch and unplug the monitor before you clean it.

- NOTE**
- To protect the LCD panel, do not scratch or rub the screen with a hard object.
 - Never use any of the following strong solvents. These will damage the cabinet and the LCD screen.

Thinner	Spray-type cleaner
Benzine	Wax
Abrasive cleaner	Acid or Alkaline solvent

- Touching the cabinet with any product made from rubber or plastic for a long time may cause degeneration or loss of paint on the cabinet.

CABINET Stains can be removed with a cloth lightly moistened with a mild detergent solvent. Then wipe the cabinet with a soft dry cloth.

LCD Periodic cleaning with a soft dry cloth is recommended.

SCREEN Don't use tissue paper etc. because these will damage the LCD screen.

BEFORE YOU OPERATE THE MONITOR

FEATURES

- ◆ Supports Resolutions up to 3840 × 2160
- ◆ High Contrast 4000:1 (Typical), Advanced Contrast Function Available, Brightness 550cd/m² (Typical)
- ◆ Moving Picture Response Time 0.4ms
- ◆ Supports AMD FreeSync™ Premium Technology (through DisplayPort input)
- ◆ Supports HDR400
- ◆ Flicker Free
- ◆ Blue Light Reducer
- ◆ Digital Character Smoothing
- ◆ 2 × 7W Stereo Speakers
- ◆ Standby Feature
- ◆ VESA Mounting Standard (200mm×100mm) Compliant
- ◆ Keyhole for Security Lock

CHECKING THE CONTENTS OF THE PACKAGE

The following accessories are included in your package. Check to see if they are enclosed with the monitor. If anything is missing or damaged, please contact your local iiyama dealer or regional iiyama office.

- | | | |
|---------------------|---------------------------|---------------------|
| ■ Power Cable * | ■ HDMI Cable | ■ DisplayPort Cable |
| ■ USB Cable | ■ Remote Control | ■ Batteries (2pcs) |
| ■ Headphone Hook | ■ Stand-Base with a screw | ■ Safety Guide |
| ■ Quick Start Guide | | |

CAUTION * All guarantees and warranties are void for any problems or damage caused by a power cable not supplied by iiyama.

An approved power cable greater or equal to H05VVf, 3G, 0.75mm² must be used.

INSTALLATION

- CAUTION** ■ Before installation, make sure the wall, ceiling or desktop arm is strong enough to hold the necessary weight of the monitor and the mount.

< WALL MOUNTING >

- CAUTION** ■ When you use with the wall mounting, in consideration of thickness of the mounting stage, tighten the M4 Screw (4pcs) which "L" length is 10mm to fasten the monitor. Using the screw longer than this may cause electric shock or damage because it may contact with the electrical parts inside the monitor.

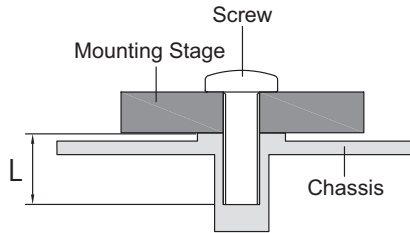

< LANDSCAPE MODE >

It is designed to be compatible in landscape mode.

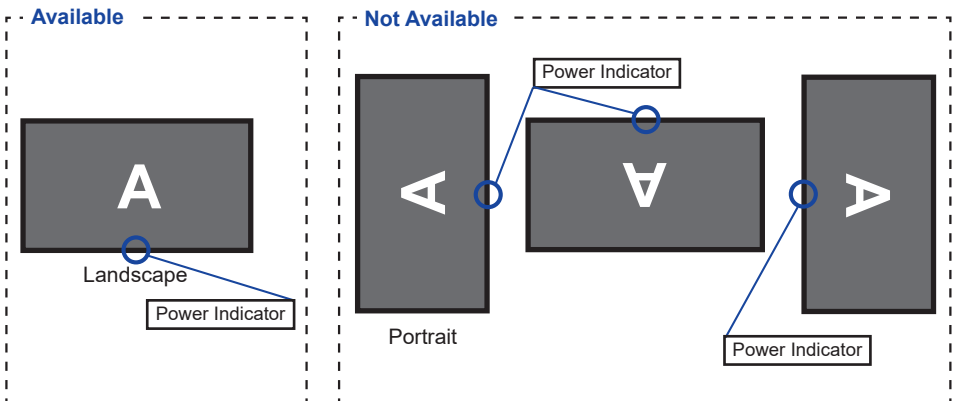

FITTING AND REMOVAL OF BASE

- CAUTION**
- Put the monitor on a stable surface. The monitor may cause injury or damage if it falls or is dropped.
 - Do not give a strong impact to the monitor. It may cause damage.
 - Unplug the monitor before removal or installation to avoid an electric shock or a damage.

<Installation>

- ① Put a piece of soft cloth on the table beforehand to prevent the monitor from being scratched.
Lay the monitor flat on a table with front face down.
- ② Install the Stand-Base as shown on below picture.
- ③ Tighten the 'thumb screw' to secure the Stand-Base to the monitor.

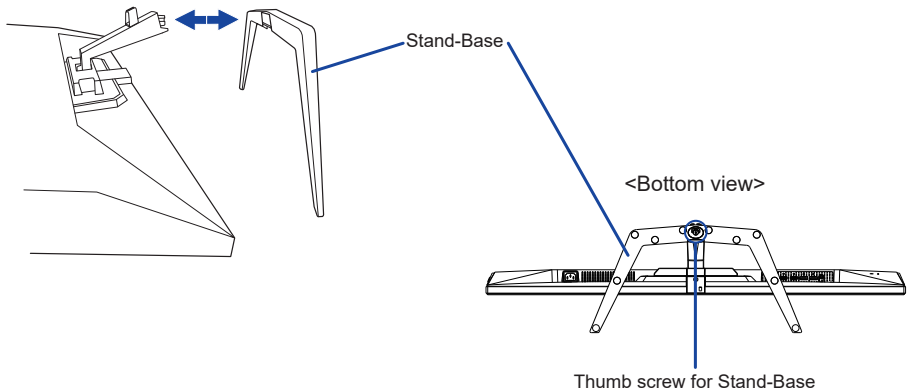

<Removal>

- ① Put a piece of soft cloth on the table beforehand to prevent the monitor from being scratched.
Lay the monitor flat on a table with front face down.
- ② Loosen the 'thumb screw' to remove the Stand-Base from the monitor.

CONTROLS AND CONNECTORS

<Front>

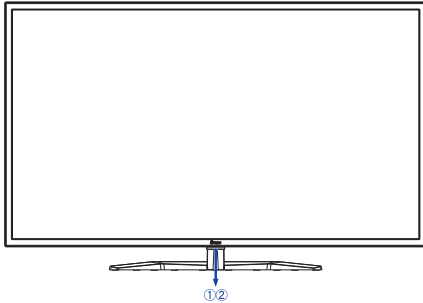

<Back>

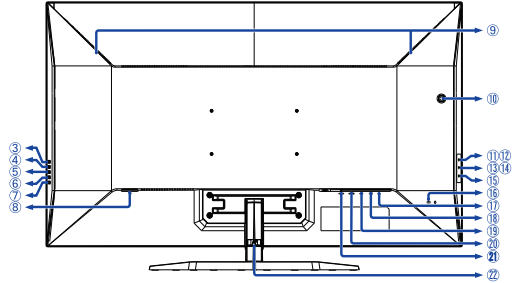

- ① Power Indicator
 - NOTE** Blue: Normal operation
 - Orange: Standby mode
- ② Remote Sensor
- ③ Input Select Button (INPUT)
- ④ + / Volume Button (+)
- ⑤ - / i-Style Color Button (-)
- ⑥ Menu Button (MENU)
- ⑦ Power Button (⏻)
- ⑧ AC Connector (~ : Alternating current)
- ⑨ Speakers
- ⑩ Headphone Hook Hole *
- ⑪ USB Downstream Connector
(⚡ USB2.0: 5V, 500mA)
- ⑫ USB Downstream Connector
(⚡ USB2.0: 5V, 500mA)
- ⑬ USB Downstream Connector
(⚡ USB3.2 Gen 1: 5Gbps, 5V, 900mA) **Blue**
- ⑭ USB Downstream Connector
(⚡ USB3.2 Gen 1: 5Gbps, 5V, 1.5A) **Yellow**
- ⑮ USB Upstream Connector (⚡)
- ⑯ Keyhole for Security Lock

NOTE You can fasten a security lock and cable to prevent the monitor from being removed without your permission.

- ⑰ Headphone Connector (🎧)
 - NOTE** Proper operation of connected external devices other than headphones is not guaranteed.
- ⑱ DisplayPort Connector (DP2)
- ⑲ DisplayPort Connector (DP1)
- ⑳ HDMI Connector (HDMI2)
- ㉑ HDMI Connector (HDMI1)
- ㉒ Cable Holder

* If necessary, attach the included Headphone Hook and turn to secure it.

FUNCTIONS OF THE REMOTE CONTROL

ENGLISH

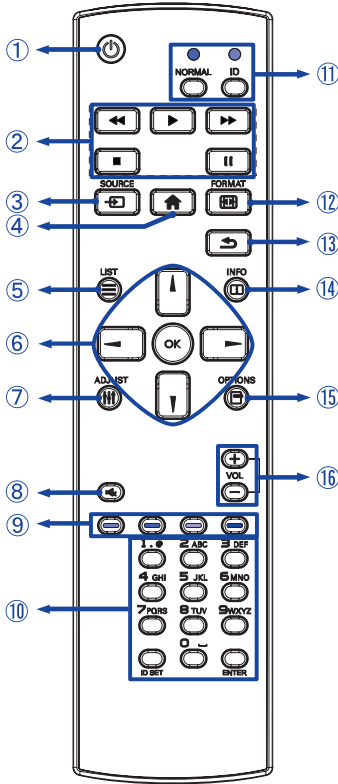

①	[POWER]	Turns the monitor ON and OFF.
②	[PLAY]	Not available on this model.
③	SOURCE	Selects the source. Press or button to select from DP1, DP2, HDMI1 or HDMI2. Press [OK] button to confirm and exit.
④	[HOME]	Opens the monitor's on-screen menu systems.
⑤	LIST	Not available on this model.
⑥		Navigates through submenus and settings. ▲: Up Button ▼: Down Button ◀: Left Button ▶: Right Button
	OK	Confirms your selection or save changes.
⑦	ADJUST	Not available on this model.
⑧	[MUTE]	Turns on or off the mute function when the Menu is not displayed.
⑨		Not available on this model.
⑩	[NUMBER] / ID SET / ENTER	Not available on this model.
⑪	NORMAL / ID	Not available on this model.
⑫	FORMAT	Open the Video Mode Adjust.
⑬	[BACK]	Returns to a previous menu or closes the OSD Menu.
⑭	INFO	Provides resolution information.
⑮	OPTIONS	Not available on this model.
⑯	VOL + / -	+ : Increases the sound volume. - : Decreases the sound volume.

PREPARING THE REMOTE CONTROL

To use the remote control, insert the two dry batteries.

CAUTION

Do not use any other batteries other than those specified in this manual for the Remote Control. Do not insert old and new batteries together in the Remote Control. Make sure that the terminals match the "+" and "-" indications in the battery compartment. Remove dead batteries immediately to prevent them from leaking into the battery compartment. Burst batteries or the electrolyte from these batteries may cause stains, fire or injury.

- ① Open the battery cover.

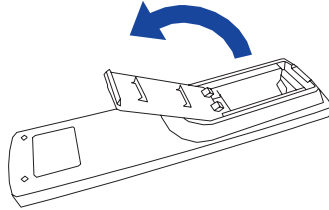

- ② Align and insert two AAA batteries according to their plus and minus ports (as indicated in the compartment).

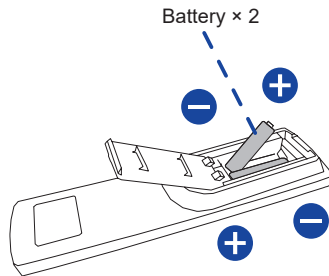

- ③ Close the battery cover.

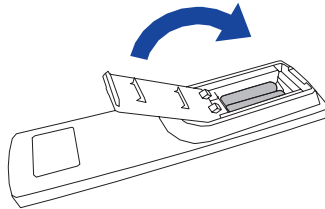



NOTE

- Refer to the above instructions when taking out the batteries.
- Replace with new batteries when the Remote Control does not work close to the monitor. Use AAA dry batteries. Risk of explosion if battery is replaced by an incorrect type.
- Operate the Remote Control by pointing it toward the Remote Sensor on the monitor.
- Other manufacturers remote control will not work with this monitor. Use the provided Remote Control ONLY.
- Used batteries needed to follow the local rules to be discarded. (Suggestion: to dispose of used batteries please follow correct policy as per your local regulations.)
- Batteries shall not be exposed to excessive heat such as sunshine, fire or the like.
- If you do not intend to use the remote control for a long period, remove the batteries.

BASIC OPERATION

■ Turning the monitor ON

The monitor is turned On and the Power Indicator turns to Blue when you press the  Button on the remote control or the monitor. The monitor is turned Off and the Power Indicator turns to Orange when you press the  Button on the remote control or the monitor. Press again to turn On the monitor.

NOTE

Even when using the standby mode or turning Off the  Button, the monitor will consume a small amount of electricity. Disconnect the Power Cable from the power supply whenever the monitor is not in use or during the night, to avoid unnecessary power consumption.

[Monitor]

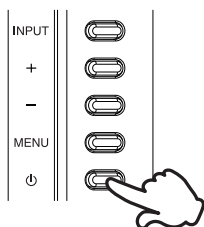

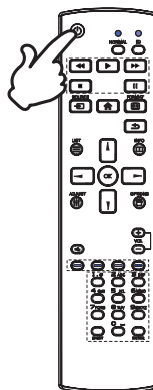

[Remote Control]



■ Display the adjustment menu page

The menu page appears on the screen when you press the  Button on the remote control or the MENU Button on the monitor.

The menu page disappears when you press the  /  Button on the remote control or the INPUT Button on the monitor.

[Monitor]

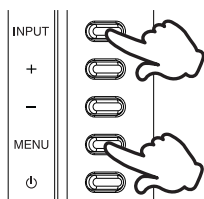

[Remote Control]

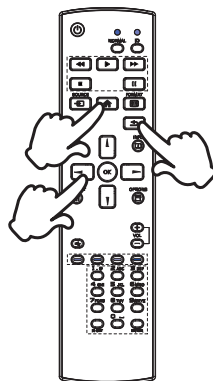

■ Move the cursor vertically

Select adjustment by pressing the ▲ / ▼ Buttons on the remote control or the + / - Buttons on the monitor while the menu page is displayed on the screen.

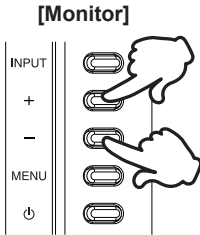

[Remote Control]

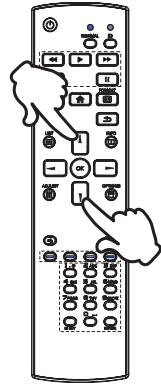

■ Move the cursor horizontally

Select menu or setting, or perform the adjustment by pressing the ◀ / ▶ Buttons on the remote control or the + / - Buttons on the monitor while the menu page is displayed on the screen.

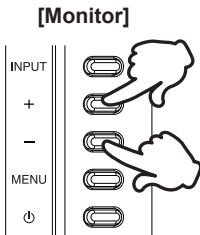

[Remote Control]

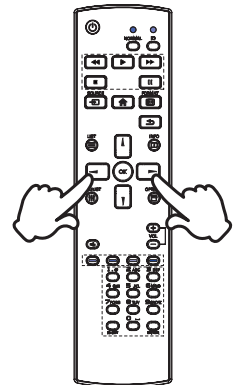

■ Adjust the volume of sound

Press the VOL+ / VOL- Buttons on the remote control or the + / - Buttons on the monitor to adjust the volume of sound when the menu page is not displayed on the screen.

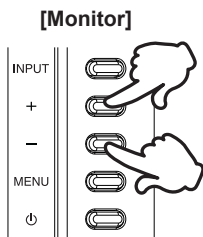

NOTE

For the monitor, press the + Button first and then adjust the volume with the + / - Buttons.

[Remote Control]

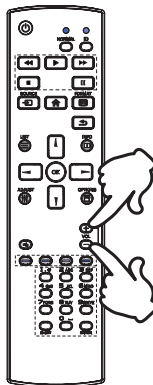

■ Switch the input signal

Press the  SOURCE Button on the remote control or the INPUT Button on the Monitor when the menu is not displayed, it shows Signal Select menu.

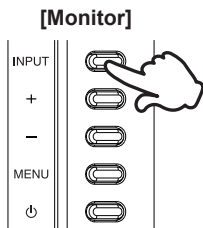

[Remote Control]

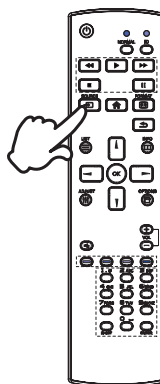

CONNECTING YOUR MONITOR

- ① Ensure that both the computer and the monitor are switched off.
- ② Connect the computer to the monitor with the signal cable.
- ③ Connect the computer to the monitor with the USB Cable.
- ④ Connect the Power Cable to the monitor first and then to the power source.
- ⑤ Turn on your monitor and computer.

NOTE

- Make sure that the building installation has a circuit breaker of 120/240V, 20A (maximum).
- The signal cables used for connecting the computer and monitor may vary with the type of computer used. An incorrect connection may cause serious damage to both the monitor and the computer. The cable supplied with the monitor is for a standard connector. If a special cable is required please contact your local iiyama dealer or regional iiyama office.
- The Class I pluggable equipment Type A must be connected to protective earth.
- The socket-outlet shall be installed near the equipment and shall be easily accessible.
- Excessive sound pressure from ear-/headphones can cause hearing damage/hearing loss.

[Example of Connection]

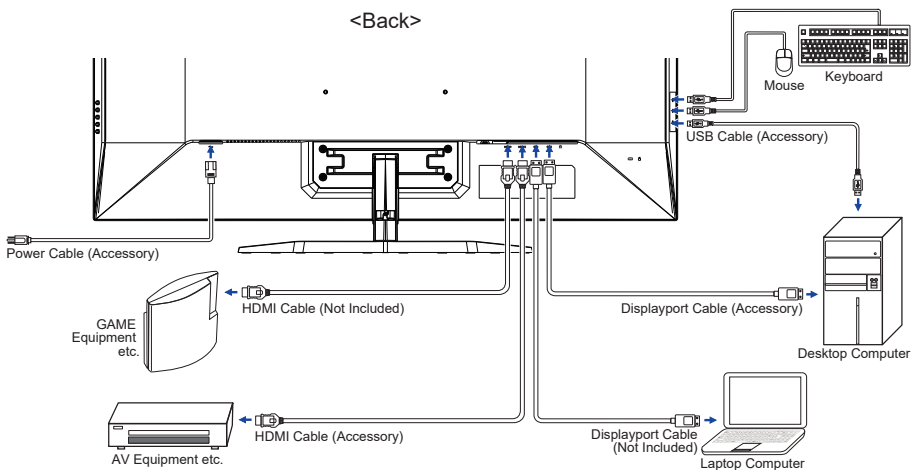

COMPUTER SETTING

■ Signal Timing

Change to the desired signal timing listed on page 34: COMPLIANT TIMING.

ADJUSTING THE VIEWING ANGLE

- For optimal viewing it is recommended to look at the full face of the monitor.
- Hold the stand so that the monitor does not topple when you change the monitor's angle.
- You are able to adjust the monitor's angle up to 10° upward, 2° downward.

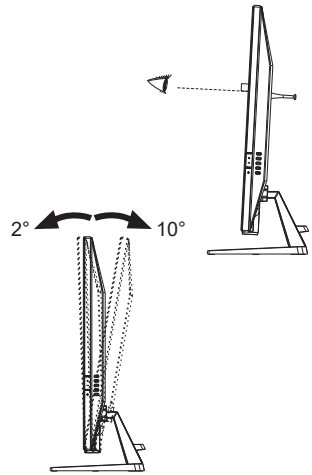

NOTE

- Do not touch the LCD screen when you change the angle. It may cause damage or break the LCD screen.
- Careful attention is required not to pinch your fingers or hands into the moving part of the stand when you change the angle.











OPERATING THE MONITOR



To create the best picture, your iiyama LCD monitor has been preset at the factory with the COMPLIANT TIMING shown on page 34. You are also able to adjust the picture by following the button operation shown below.

- 1 Press the  Button on the remote control or the MENU Button on the monitor to start the On Screen Display feature. There are additional Menu items which can be switched by using the  /  Buttons on the remote control or the + / - Buttons on the monitor.





- 2 Select the Menu item which contains the adjustment icon relating to the adjustment you want to make. Press the OK Button on the remote control or the MENU Button on the monitor. Then, use the  /  Buttons on the remote control or the + / - Buttons on the monitor to highlight the desired adjustment icon.
- 3 Press the OK Button on the remote control or the MENU Button on the monitor again. Use the  /  Buttons on the remote control or the + / - Buttons on the monitor to make the appropriate adjustment or setting.
- 4 Press the OK Button on the remote control or the MENU Button on the monitor, then the  /  Button on the remote control or the INPUT Button on the monitor to leave the menu, and the settings you just made would be automatically saved.

For example, to correct for OSD vertical position, select Menu item of Setup Menu and then press the OK Button on the remote control or the MENU Button on the monitor. Then, select OSD Vertical Position by using the  /  Buttons on the remote control or the + / - Buttons on the monitor.

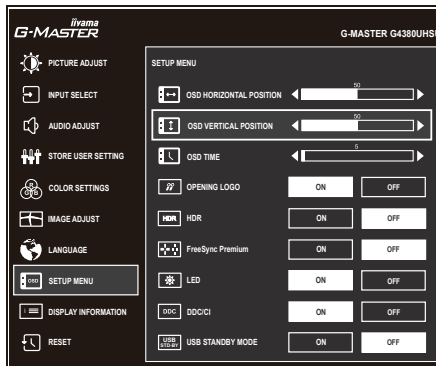
An adjustment scale becomes active after you press the OK Button on the remote control or the MENU Button on the monitor. Then, use the  /  Buttons on the remote control or the + / - Buttons on the monitor to change the OSD vertical position settings. The OSD vertical position of the overall display should be changing accordingly while you are doing this.

































Press the OK Button on the remote control or the MENU Button on the monitor and finally the  /  Button on the remote control or the INPUT Button on the monitor to close the On Screen Display feature. All changes are saved in the memory.

NOTE

- When Button operations are aborted during adjustment, On-Screen Display disappears when the time set for the OSD Time has passed. Also, the ◀ / ▶ Button on the remote control or the INPUT Button on the monitor can be used to return previous menu and turn off the On-Screen Display.
- Any changes are automatically saved in the memory when the On Screen Display disappears. Turning off the power should be avoided while using the Menu.

ADJUSTMENT MENU CONTENTS



Adjustment Item	Problem / Option	Button to Press
Contrast	Too dark Too bright	      
Brightness *2	Too dull Too intense	     
Overdrive	Off / 1 / 2 / 3 / 4 / 5 It will improve the gray level response time of the LCD panel. A higher level results in a faster response time.	     
Adv. Contrast	On	Increased Contrast Ratio
	Off	Typical Contrast Ratio
Eco	Off	Normal
	Mode1	Brightness of back-light is reduced.
	Mode2	Brightness of back-light is reduced more than Mode1.
	Mode3	Brightness of back-light is reduced more than Mode2.
Blue Light Reducer Direct	Off	Typical
	Mode1	Blue light is reduced.
	Mode2	Blue light is reduced more than Mode1.
	Mode3	Blue light is reduced more than Mode2.
Black Tuner	From -5 to +5 You can adjust Dark shades.	     
MBR *3	Off / 0 / 1 / 2 / 3 / 4 / 5 / 6 / 7 Improve the moving picture response time of the LCD panel.	     
Gamma	Gamma1	
	Gamma2	
	Gamma3	

*1 The availability of each item depends on which item is activated. See the Function Correlation Matrix on page 29 for more details.

*2 Adjust the Brightness when you are using the monitor in a dark room and feel the screen is too bright.

*3 MBR is available only when the refresh rate is 75Hz or more.

Direct

You can skip the Menu items and directly display an option setting screen by using the following button operations.

- Blue Light Reducer: Keep pressing the – Button on the monitor for 3 seconds when the Menu is not displayed.



Input Select

Direct

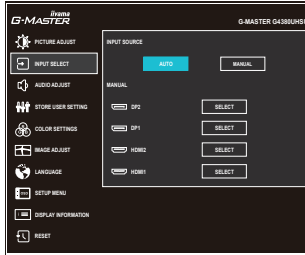

Adjustment Item	Option		
Input Source	Auto	Search for an available input source and select automatically.	
	Manual	DP2	Select the Digital (DisplayPort2) input.
		DP1	Select the Digital (DisplayPort1) input.
		HDMI2	Select the Digital (HDMI2) input.
		HDMI1	Select the Digital (HDMI1) input.

NOTE Input source is fixed, not selected automatically when HDMI and DisplayPort which are selected.

Direct

You can skip the Menu items and directly display an option setting screen by using the following button operations.

- Input Select: Press the SOURCE Button on the remote control or the INPUT Button on the monitor when the Menu is not displayed, it shows following Menu.

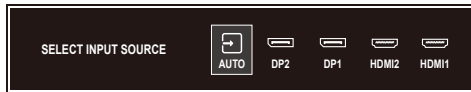



Audio Adjust

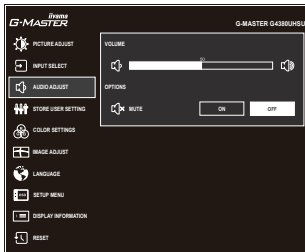

Adjustment Item	Problem / Option	Button to Press
Volume Direct	Too soft Too loud	+ -
Mute Direct	On	Turn off the sound temporarily.
	Off	Return the sound volume to the previous level.

NOTE Mute On and Off are switched as follows by pressing the / or the + / - Buttons successively. → On → Off

Direct

You can skip the Menu items and directly display an adjustment scale or an option setting screen by using the following button operations.

- Volume: Press the VOL + / - Buttons on the remote control or the + Button on the monitor when the Menu is not displayed.
- Mute: Press the Button on the remote control or keep pressing the + Button on the monitor for 3 seconds when the Menu is not displayed.



Store User Setting

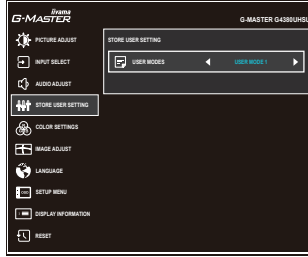

Adjustment Item	Option	
User Modes	User Mode 1	Save the settings of the screen adjustment.
	User Mode 2	Save the settings of the screen adjustment.
	User Mode 3	Save the settings of the screen adjustment.

NOTE The monitor memorizes your customized settings below. Those settings can be invoked from "i-Style Color" menu of "Image Adjust" later.

Contrast, Brightness, Overdrive, Adv. Contrast, Eco, Black Tuner, MBR, Gamma, Volume, Mute, Color Settings, Sharp and Soft, Video Mode Adjust



Color Settings *

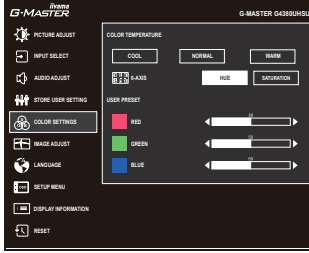

ENGLISH

Adjustment Item	Problem / Option		Button to Press	
Color Temperature	Cool	Cool color		
	Normal	Normal color		
	Warm	Warm color		
6-Axis	Hue	Red	Too weak Too strong	+ -
		Yellow		
		Green		
		Cyan		
		Blue		
		Magenta		
	Saturation	Red	Too weak Too strong	+ -
		Yellow		
		Green		
		Cyan		
Magenta				
User Preset	Red	Too weak Too strong	+ -	
	Green			
	Blue			

* Disabled when Blue Light Reducer or HDR is active.

Image Adjust

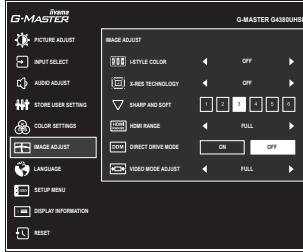

Adjustment Item	Option	Button to Press
i-Style Color Direct	Off	Return to a state set by color adjustment except i-Style Color.
	Standard *1	For general windows environment and monitor default setting
	Sport Game *1	For Sports game environment
	FPS Game *1	For FPS game environment
	Strategy Game *1	For Strategy game environment
	Text *1	For text editing and viewing in a word processing environment
	User Mode 1	Applies customized monitor settings.
	User Mode 2	Applies customized monitor settings.
	User Mode 3	Applies customized monitor settings.
X-Res Technology *1	Off	Normal
	Soft	Enhance the picture edge.
	Middle	Enhance the picture edge more than the Soft option.
	Hard	Enhance the picture edge more than the Middle option.
Sharp and Soft	1 2 3 4 5 6 You can change the picture quality from 1 to 6 (sharp to soft). Press the / + Button to change the picture quality in numerical order. Press the / - Button to change the picture quality in reverse numerical order.	+ -
HDMI Range *2	Full	For full-range color scale signal
	Limited	For limited color scale signal
Direct Drive Mode *3	On	Reduce the input-lag.
	Off	Typical
NOTE Changing Resolution and Refresh rate or turning Power Off/On might disable the Direct Drive Mode function.		

*1 Disabled when HDR is active.

*2 Available for HDMI input only.

*3 The availability of each item depends on which item is activated. See the Function Correlation Matrix on page 29 for more details.

Direct

You can skip the Menu items and directly display an option setting screen by using the following button operations.

- i-Style Color: Press the – Button on the monitor when the Menu is not displayed.

Image Adjust

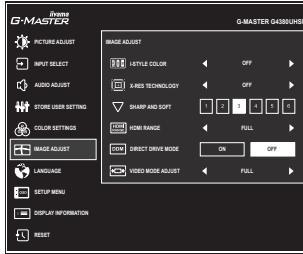

Adjustment Item	Option	
Video Mode Adjust *3	Full	Expansion display
	Aspect *4	Expansion display of Aspect
	Dot by dot *5	Display the picture dot by dot.
	17inch	Display the picture as 17 inch screen (5 : 4).
	19inch	Display the picture as 19 inch screen (5 : 4).
	19.5inch	Display the picture as 19.5 inch screen (16 : 9).
	21.5inch	Display the picture as 21.5 inch screen (16 : 9).
	23inch	Display the picture as 23 inch screen (16 : 9).
	23.8inch	Display the picture as 23.8 inch screen (16 : 9).
	24inch	Display the picture as 24 inch screen (16 : 9).
	24.5inch	Display the picture as 24.5 inch screen (16 : 9).
	27inch	Display the picture as 27 inch screen (16 : 9).
	31.5inch	Display the picture as 31.5 inch screen (16 : 9).
34inch	Display the picture as 34 inch screen (16 : 9).	

*3 The availability of each item depends on which item is activated. See the Function Correlation Matrix on page 29 for more details.

*4 Available only with 16:10, 5:4 and 4:3 resolutions.

*5 Available only at resolutions 2560 × 1440 or less.



Language

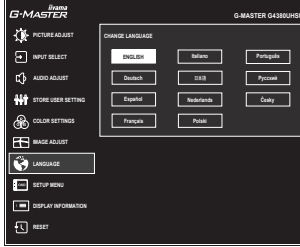

Adjustment Item	Option			
Language	English	English	Nederlands	Dutch
	Deutsch	German	Polski	Polish
	Español	Spanish	Português	Portuguese
	Français	French	Русский	Russian
	Italiano	Italian	Česky	Czech
	日本語	Japanese		

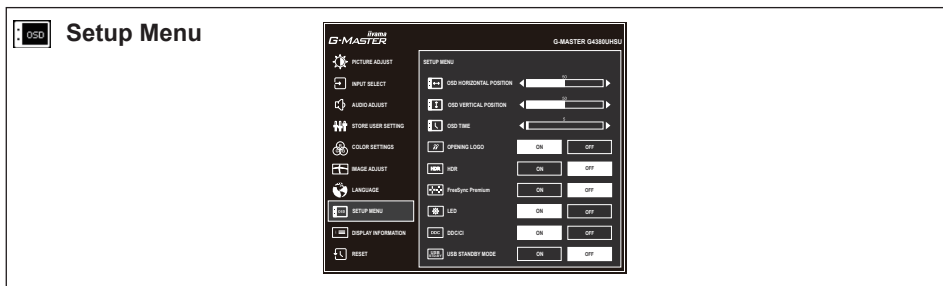

Adjustment Item	Problem / Option	Button to Press
OSD Horizontal Position	OSD is too left OSD is too right	+ -
OSD Vertical Position	OSD is too low OSD is too high	+ -
OSD Time	You can set the OSD display duration time between 5 and 30 seconds.	+ -
Opening Logo	On	G-MASTER Logo is displayed when the monitor is turned on.
	Off	G-MASTER Logo is not displayed when the monitor is turned on.
HDR * ¹	On	For HDR (High Dynamic Range) signal
	Off	For normal signal
FreeSync Premium * ^{1,2}	On	Enable the FreeSync function.
	Off	The FreeSync function is turned Off.
LED	On	The Power Indicator is turned On.
	Off	The Power Indicator is turned Off.
NOTE Turn Off the Power Indicator when you are bothered by the light.		
DDC/CI	On	DDC/CI is On.
	Off	DDC/CI is Off.
USB Stanby mode	On	The USB hub enters into the standby mode in synchronization with the monitor.
	Off	The USB hub remains activated if the monitor enters into the standby mode.

*¹ The availability of each item depends on which item is activated. See the Function Correlation Matrix on page 29 for more details.

*² Available for DisplayPort input only.



Displays information regarding the current input signal coming from the graphic card in your computer.

NOTE See your graphic card user guide for more information about changing the resolution and refresh.

 <p>Reset Direct</p>	
Adjustment Item	Option
Yes	Factory-preset data is restored.

Direct

You can skip the Menu items and directly perform "Reset" by using the following button operations.

- Reset: While the monitor is turned Off, press the  Button and the INPUT Button on the monitor at the same time.

● **Lock Mode:**

<OSD>

If you turn on the monitor with holding down the MENU Button on the monitor while the monitor is off, the OSD button operations will be locked / unlocked.

<Power / OSD>

If you keep pressing the MENU Button on the monitor for 10 seconds when the Menu is not displayed, the Power / OSD button operations will be locked / unlocked.

■ Function Correlation Matrix

Selected item		Picture Adjust										Image Adjust			Setup Menu		
		Contrast	Brightness	Overdrive	Adv. Contrast	Eco	Blue Light Reducer	Black Tuner	MBR	Gamma	Direct Drive Mode	Video Mode Adjust	Full / Aspect	Dot by dot / 17-34inch	HDR	FreeSync Premium	
Active item	Adv. Contrast	-	✓	✓	-	-	✓	-	✓	✓	✓	✓	✓	-	-	-	
	Eco	✓	-	✓	-	-	✓	-	✓	✓	✓	✓	✓	-	✓	✓	
	Blue Light Reducer	✓	✓	✓	-	-	✓	-	✓	✓	✓	✓	✓	-	✓	✓	
	MBR	✓	-	-	-	-	-	-	✓	✓	✓	✓	✓	-	-	-	
Image Adjust	i-Style Color	Standard / Sport Game / FPS Game / Strategy Game / Text	-	-	-	-	-	-	-	✓	✓	✓	✓	✓	-	-	-
		User Mode 1/2/3	✓	✓	✓	✓	✓	✓	✓	✓	✓	✓	✓	✓	✓	✓	✓
		On	✓	✓	✓	✓	✓	✓	✓	✓	✓	✓	✓	✓	✓	✓	✓
	Direct Drive Mode	Off	✓	✓	-	✓	✓	✓	-	✓	✓	✓	✓	✓	✓	✓	-
		Full / Aspect	✓	✓	✓	✓	✓	✓	✓	✓	✓	✓	✓	✓	✓	✓	✓
	Video Mode Adjust	Dot by dot / 17-34inch	✓	✓	-	✓	✓	✓	-	✓	✓	✓	✓	✓	✓	✓	✓
HDR		-	-	✓	-	✓	-	-	-	-	-	-	-	-	-	-	
Setup Menu	FreeSync Premium	✓	✓	✓	-	✓	✓	-	✓	✓	✓	✓	✓	✓	✓	✓	

✓ : Available

- : Not available

STANDBY FEATURE

This product features the standby function. When activated, it automatically reduces unnecessary power consumption of the monitor when your computer is not in use.

There is a standby step the monitor takes as described below. The standby function, including any timer settings is configured by the operating system. Check your operating system manual for information on how this can be configured.

■ Standby Mode

When the video signal from the computer is off, the monitor enters into Standby Mode which reduces the power consumption to 0.5W or less*. The screen becomes dark, and the power indicator turns to orange. From Standby Mode, the image reappears in several seconds when either the keyboard or the mouse are touched again.

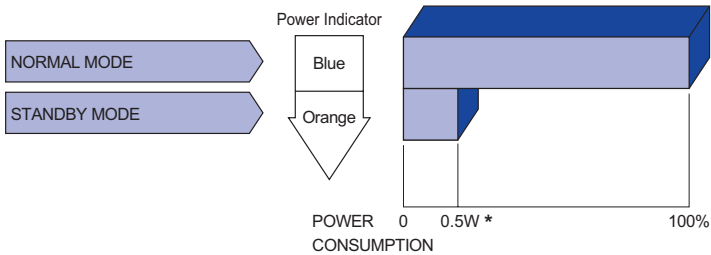

* When the "USB Standby mode" of "Setup Menu" is On.

TROUBLE SHOOTING

If the monitor fails to operate correctly, please follow the steps below for a possible solution.

1. Perform the adjustments described in OPERATING THE MONITOR, depending on the problem you have. If the monitor does not get a picture, skip to 2.
2. Consult the following items if you cannot find an appropriate adjustment item in OPERATING THE MONITOR or if the problem persists.
3. If you are experiencing a problem which is not described below or you cannot correct the problem, discontinue using the monitor and contact your dealer or iiyama service center for further assistance.

Problem	Check
① The picture does not appear. (Power indicator does not light up.) (Power indicator is blue.) (Power indicator is orange.)	<input type="checkbox"/> The Power Cable is firmly seated in the socket. <input type="checkbox"/> The Power Switch is turned ON. <input type="checkbox"/> The AC socket is live. Please check with another piece of equipment. <input type="checkbox"/> If the blank screen saver is in active mode, touch the keyboard or the mouse. <input type="checkbox"/> Increase the Contrast and/or Brightness. <input type="checkbox"/> The computer is ON. <input type="checkbox"/> The Signal Cable is properly connected. <input type="checkbox"/> The signal timing of the computer is within the specification of the monitor. <input type="checkbox"/> If the monitor is in standby mode, touch the keyboard or the mouse. <input type="checkbox"/> The computer is ON. <input type="checkbox"/> The Signal Cable is properly connected. <input type="checkbox"/> The signal timing of the computer is within the specification of the monitor.
② The screen is not synchronized.	<input type="checkbox"/> The Signal Cable is properly connected. <input type="checkbox"/> The signal timing of the computer is within the specification of the monitor.
③ The screen position is not in the center.	<input type="checkbox"/> The signal timing of the computer is within the specification of the monitor.
④ The screen is too bright or too dark.	<input type="checkbox"/> The video output level of the computer is within the specification of the monitor.

Problem

Check

- | | |
|---------------------------------------|--|
| ⑤ The screen is shaking. | <input type="checkbox"/> The power voltage is within the specification of the monitor. |
| | <input type="checkbox"/> The signal timing of the computer is within the specification of the monitor. |
| ⑥ No sound. | <input type="checkbox"/> The audio equipment (computer etc.) is ON. |
| | <input type="checkbox"/> The Volume is turned up. |
| | <input type="checkbox"/> The Mute is OFF. |
| | <input type="checkbox"/> The audio output level of the audio equipment is within the specification of the monitor. |
| ⑦ The sound is too loud or too quiet. | <input type="checkbox"/> The audio output level of the audio equipment is within the specification of the monitor. |

RECYCLING INFORMATION

For better environment protection please don't dispose your monitor.
Please visit our web site: <https://iiyama.com> for monitor recycling.

APPENDIX

Design and specifications are subject to change without prior notice.

SPECIFICATIONS : G-MASTER G4380UHSU-B1 A

Size Category	43"	
LCD Panel	Panel technology	VA
	Size	Diagonal: 42.5" (108cm)
	Pixel pitch	0.245mm H × 0.245mm V
	Brightness	550cd/m ² (Typical), 205cd/m ² (Default / Energy Saving)
	Contrast ratio	4000 : 1 (Typical), Advanced Contrast Function Available
	Viewable angle	Right / Left: 89° each, Up / Down: 89° each (Typical)
	MPRT	0.4ms
Display Colors	Approx. 1.07 Billion	
Sync Frequency	HDMI: Horizontal: 30.0-135.0kHz, Vertical: 30-120Hz DisplayPort (FreeSync: Off): Horizontal: 30.0-330.0kHz, Vertical: 48-144Hz DisplayPort (FreeSync: On): Horizontal: 30.0-275.0kHz, Vertical: 48-120Hz	
Native Resolution	3840 × 2160, 8.2 MegaPixels	
Support max. resolution	HDMI: 3840 × 2160 60Hz 2560 × 1440 120Hz DisplayPort (FreeSync: Off): 3840 × 2160 144Hz DisplayPort (FreeSync: On): 3840 × 2160 120Hz	
Input Connector	HDMI × 2, DisplayPort × 2	
Input Video Signal	HDMI, DisplayPort	
USB Standard	USB2.0 (DC5V, 500mA) USB3.2 Gen 1 (5Gbps, DC5V, 900mA / 1.5A)	
Number of USB Ports	1 Upstream: Series B	
Connector shape	4 Downstream: Series A (USB2.0 × 2, USB3.2 Gen 1 × 2)	
Headphone Connector ^{*1}	ø 3.5mm mini jack (Stereo)	
Speakers	7W × 2 (Stereo speakers)	
Maximum Screen Size	941.18mm W × 529.42mm H / 37.1" W × 20.8" H	
Power Source	100-240VAC, 50/60Hz, 1.5A	
Power Consumption ^{*2}	85W (Typical), 49W (Default / Energy Saving) Standby mode: 0.5W maximum, Off mode: 0.3W maximum	
Dimensions ^{*3}	977.5 × 621.5 × 251.0mm / 38.5 × 24.5 × 9.9" (W×H×D)	
Net Weight	14.9kg / 32.8lbs	
Tilt Angle	Upward: 10°, Downward: 2°	
Environmental Considerations	Operating: Temperature 5 to 35°C / 41 to 95°F Humidity 10 to 80% (No condensation) Storage: Temperature -20 to 60°C / -4 to 140°F Humidity 5 to 85% (No condensation)	
Approvals	CE, UKCA, TÜV-Bauart, EAC, VCCI, PSE	

- NOTE** ^{*1} Proper operation of connected external devices other than headphones is not guaranteed.
^{*2} When the "USB Standby mode" of "Setup Menu" is On.
^{*3} Protruding portions are not included.

DIMENSIONS

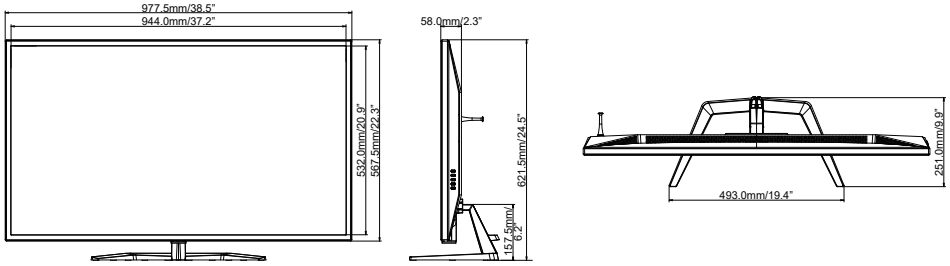

COMPLIANT TIMING

Video Mode	Horizontal Frequency	Vertical Frequency	Dot Clock	
800 × 600	37.879kHz	60.317Hz	40.000MHz	
	46.875kHz	75.000Hz	49.500MHz	
1024 × 768	48.363kHz	60.004Hz	65.000MHz	
	60.023kHz	75.029Hz	78.750MHz	
1280 × 1024	63.981kHz	60.020Hz	108.000MHz	
	79.976kHz	75.025Hz	135.000MHz	
1680 × 1050	65.290kHz	60.000Hz	146.250MHz	
1920 × 1080	67.500kHz	60.000Hz	148.500MHz	
	137.280kHz	120.000Hz	285.542MHz	
2560 × 1440	183.000kHz	120.000Hz	497.760MHz	
3840 × 2160	67.500kHz	30.000Hz	297.000MHz	^{*1}
	135.000kHz	60.000Hz	594.000MHz	
	179.440kHz	80.000Hz	703.405MHz	^{*2}
	226.500kHz	100.000Hz	887.880MHz	^{*2}
	274.440kHz	120.000Hz	1075.805MHz	^{*2}
	329.330kHz	144.000Hz	1290.966MHz	^{*2,3}

- NOTE**
- ^{*1} Available for HDMI input only.
 - ^{*2} Available for DisplayPort input only.
 - ^{*3} Available only when the FreeSync function is Off.

Console	1080p (1920×1080)	1440p (2560×1440)	2160p (3840×2160)
PS5	60 / 120Hz	—	60Hz
Xbox Series X/S	60 / 120Hz	120Hz	60Hz