

USER MANUAL

ProLite

LCD Monitor

ENGLISH

ProLite XUB2797UHSNP

Thank you very much for choosing the iiyama LCD monitor.

We recommend that you take a few minutes to read this comprehensive manual carefully before installing and switching on the monitor. Please keep this manual in a safe place for your future reference.



Dear user, we congratulate you on the purchase of your iiyama LCD.

For details on warranty and locally used pixel policies that apply directly after installation of your product please check the iiyama website.

To report a fault, please contact your local support centre found at <https://iiyama.com>

Things to check before you call the iiyama information line

- | if the power cable is connected securely and turned on?
- | if the display has been turned on?
- | if the signal cable is connected securely and the correct input selected?
- | if the computer has been restarted with the display connected?
- | if the graphics card is correctly installed with the latest drivers possible?
- | if the correct native resolution has been selected via 'Display Properties'?
- | If the R/G/B signal configuration is correct?
- | if the displays On Screen Menu is shown?
- | if the correct brightness and contrast settings have been set?
- | if given display tolerances and compatibility have been considered?
- | if via the On Screen Menu you have performed a Factory Reset/Recall?

Before reporting the screen defect, please prepare the following information/evidence:

- | model number *
- | purchase receipt and serial number *
- | name and address for collection
- | telephone/fax number, for availability during the day
- | convenient collection date (date, time)
- | short description of the defect

Important Note:

If there is no fault found in the collected equipment after inspection, the transferring party shall incur charges for transport and administration.

If you have checked all of the above and there is still no picture, call our information line for assistance in your country.

Feedback on health and safety issues

If you have any health and safety concerns or questions about the product (including when using the product), please contact iiyama support through our website. You can also contact us by calling +31 204460404. After receiving your feedback, we will ask the responsible unit to handle it as soon as possible and a dedicated person will get back to you. Your feedback will also be recorded and incorporated into our evaluation for improvements

* see the identification plate on the back of the case.

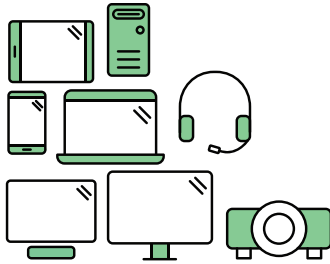

Say hello to a more sustainable product

IT products are associated with a wide range of sustainability risks throughout their life cycle. Human rights violations are common in the factories. Harmful substances are used both in products and their manufacture. Products can often have a short lifespan because of poor ergonomics, low quality and when they are not able to be repaired or upgraded.

This product is a better choice. It meets all the criteria in TCO Certified, the world's most comprehensive sustainability certification for IT products. Thank you for making a responsible product choice, that help drive progress towards a more sustainable future!

Criteria in TCO Certified have a life-cycle perspective and balance environmental and social responsibility. Conformity is verified by independent and approved verifiers that specialize in IT products, social responsibility or other sustainability issues. Verification is done both before and after the certificate is issued, covering the entire validity period. The process also includes ensuring that corrective actions are implemented in all cases of factory non-conformities. And last but not least, to make sure that the certification and independent verification is accurate, both TCO Certified and the verifiers are reviewed regularly.

Want to know more?

Read information about TCO Certified, full criteria documents, news and updates at [tcocertified.com](https://www.tcocertified.com). On the website you'll also find our Product Finder, which presents a complete, searchable listing of certified products.

CE MARKING DECLARATION OF CONFORMITY

This LCD monitor complies with the requirements of the EC/EU Directive 2014/30/EU "EMC Directive", 2014/35/EU "Low Voltage Directive", 2009/125/EC "ErP Directive" and 2011/65/EU "RoHS Directive".

The electro-magnetic susceptibility has been chosen at a level that gives correct operation in residential areas, business and light industrial premises and small-scale enterprises, inside as well as outside of the buildings. All places of operation are characterised by their connection to the public low voltage power supply system.

IYYAMA CORPORATION: Wijkemeerstraat 8, 2131 HA Hoofddorp, The Netherlands

Model No. : PL2797UH



We recommend recycling of used product. Please contact your dealer or iiyama service center. Recycle information is obtained via the Internet, using the address:
<https://iiyama.com>

You can access the Web page of different countries from there.

- We reserve the right to change specifications without notice.
- All trademarks used in this user manual are the property of their respective owners.
- Eprel registration number XUB2797UH SNP-B1 : 1955679

TABLE OF CONTENTS

FOR YOUR SAFETY.....	1
SAFETY PRECAUTIONS.....	1
SPECIAL NOTES ON LCD MONITORS.....	3
CUSTOMER SERVICE.....	3
CLEANING.....	3
BEFORE YOU OPERATE THE MONITOR.....	4
FEATURES.....	4
CHECKING THE CONTENTS OF THE PACKAGE.....	4
USING ARM OR STAND.....	5
FITTING AND REMOVAL OF STAND.....	7
CONTROLS AND CONNECTORS.....	9
CONNECTING YOUR MONITOR.....	10
DISCONNECTING YOUR MONITOR.....	12
COMPUTER SETTING.....	12
ADJUSTING THE HEIGHT AND THE VIEWING ANGLE.....	12
OPERATING THE MONITOR.....	13
ADJUSTMENT MENU CONTENTS.....	14
STANDBY FEATURE.....	27
TROUBLE SHOOTING.....	28
RECYCLING INFORMATION.....	29
APPENDIX.....	30
SPECIFICATIONS : ProLite XUB2797UHSNP-B1.....	30
DIMENSIONS.....	31
COMPLIANT TIMING.....	31

FOR YOUR SAFETY

SAFETY PRECAUTIONS

WARNING

STOP OPERATING THE MONITOR WHEN YOU SENSE TROUBLE

If you notice any abnormal phenomena such as smoke, strange sounds or fumes, unplug the monitor and contact your dealer or iiyama service center immediately. Further use may be dangerous and can cause fire or electric shock.

NEVER REMOVE THE CABINET

High voltage circuits are inside the monitor. Removing the cabinet may expose you to the danger of fire or electric shock.

DO NOT PUT ANY OBJECT INTO THE MONITOR

Do not put any solid objects or liquids such as water into the monitor. In case of an accident, unplug your monitor immediately and contact your dealer or iiyama service center. Using the monitor with any object inside may cause fire, electric shock or damage.

INSTALL THE MONITOR ON A FLAT, STABLE SURFACE

The monitor may cause an injury if it falls or is dropped.

DO NOT USE THE MONITOR NEAR WATER

Do not use where water may be splashed or spilt onto the monitor as it may cause fire or electric shock.

OPERATE UNDER THE SPECIFIED POWER SUPPLY

Be sure to operate the monitor only with the specified power supply. Use of an incorrect voltage will cause malfunction and may cause fire or electric shock.

PROTECT THE CABLES

Do not pull or bend the power cable and signal cable. Do not place the monitor or any other heavy objects on the cables. If damaged, the cables may cause fire or electric shock.

ADVERSE WEATHER CONDITIONS

It is advisable not to operate the monitor during a heavy thunder storm as the continual breaks in power may cause malfunction. It is also advised not to touch the plug in these circumstances as it may cause electric shock.

CAUTION

INSTALLATION LOCATION

Do not install the monitor where sudden temperature changes may occur, or in humid, dusty or smoky areas as it may cause fire, electric shock or damage. You should also avoid areas where the sun shines directly on the monitor.

DO NOT PLACE THE MONITOR IN A HAZARDOUS POSITION

The monitor may topple and cause injury if not suitably located. Please also ensure that you do not place any heavy objects on the monitor, and that all cables are routed such that children may not pull the cables and possibly cause injury.

MAINTAIN GOOD VENTILATION

Ventilation slots are provided to keep the monitor from overheating. Covering the slots may cause fire. To allow adequate air circulation, place the monitor at least 10cm (or 4 inches) from any walls.

When removing the tilt stand, the ventilation slots on the back side of the monitor can be blocked. This may overheat the monitor and may cause fire or damage. Make sure to allow enough ventilation when removing the tilt stand. Operating the monitor on its back, side, upside down or on a carpet or any other soft material may also cause damage.

DISCONNECT THE CABLES WHEN YOU MOVE THE MONITOR

When you move the monitor, turn off the power switch, unplug the monitor and be sure the signal cable is disconnected. If you do not disconnect them, it may cause fire or electric shock.

UNPLUG THE MONITOR

If the monitor is not in use for a long period of time it is recommended that it is left unplugged to avoid accidents.

HOLD THE PLUG WHEN DISCONNECTING

To disconnect the power cable or signal cable, always pull it by the plug. Never pull on the cable itself as this may cause fire or electric shock.

DO NOT TOUCH THE PLUG WITH WET HANDS

Pulling or inserting the plug with wet hands may cause electric shock.

WHEN YOU INSTALL THE MONITOR ON YOUR COMPUTER

Be sure the computer is strong enough to hold the weight of the monitor, otherwise, you may damage your computer.

CAREFUL! PROTECT YOUR HANDS AND FINGERS

- Be careful not to hurt your fingers or hands when you change the height or the angle.
- Injury can occur if care is not taken to avoid finger contact with the displays base when adjusting the height.

REMARK FOR 24/7 USAGE

This product is not specifically designed for 24/7 usage in all environments.

REMARK SPECIFIC TO DESKTOP USE

This product is designed for desktop use, not for digital signage (electronic signboard) applications such as ceiling hanging or wall mounting.

OTHERS

ERGONOMIC RECOMMENDATIONS

To eliminate eye fatigue, do not operate the monitor against a bright background or in a dark room. For optimal viewing comfort, the monitor should be just below eye level and 40-60cm (16-24 inches) away from your eyes. When using the monitor over a prolonged time, a ten minute break every hour is recommended as looking at the screen continuously can cause eye strain.

SPECIAL NOTES ON LCD MONITORS

The following symptoms are normal with LCD monitors and do not indicate a problem.

NOTE

- When you first turn on the LCD monitor, the picture may not fit in the display area because of the type of computer that is used. In this case, adjust the picture position to the correct position.
- You may find slightly uneven brightness on the screen depending on the desktop pattern you use.
- Due to the nature of the LCD screen, an afterimage of the previous screen may remain after switching the image, when the same image is displayed for hours. In this case, the screen can be recovered slowly by changing the image or turning off the Power Switch for some hours.

CUSTOMER SERVICE

NOTE

- If you have to return your unit for service and the original packaging has been discarded, please contact your dealer or iiyama service center for advice or replacement packaging.

CLEANING

WARNING

- If you drop any materials or liquids such as water into the monitor when cleaning, unplug the power cable immediately and contact your dealer or iiyama service center.

CAUTION

- For safety reasons, turn off the power switch and unplug the monitor before you clean it.

NOTE

- To protect the LCD panel, do not scratch or rub the screen with a hard object.
- Never use any of the following strong solvents. These will damage the cabinet and the LCD screen.

Thinner	Spray-type cleaner
Benzine	Wax
Abrasive cleaner	Acid or Alkaline solvent

- Touching the cabinet with any product made from rubber or plastic for a long time may cause degeneration or loss of paint on the cabinet.

CABINET

Stains can be removed with a cloth lightly moistened with a mild detergent solvent. Then wipe the cabinet with a soft dry cloth.

LCD SCREEN

Periodic cleaning with a soft dry cloth is recommended.

Don't use tissue paper etc. because these will damage the LCD screen.

BEFORE YOU OPERATE THE MONITOR

FEATURES

- ◆ Supports Resolutions up to 3840 × 2160
- ◆ High Contrast 1300:1 (Typical), Advanced Contrast Function Available, Brightness 350cd/m² (Typical), Quick Response Time 4ms (Gray to Gray)
- ◆ Flicker - Free
- ◆ Blue Light Reducer
- ◆ Digital Character Smoothing
- ◆ USB Type-C / RJ45 / DP Out - Connectors
- ◆ USB Power Delivery supports up to 96W
- ◆ 2 × 2W Stereo Speakers
- ◆ Ergonomic Design TCO Certified
- ◆ Standby Feature
- ◆ VESA Mounting Standard (100mm×100mm) Compliant
- ◆ Keyhole for Security Lock

CHECKING THE CONTENTS OF THE PACKAGE

The following accessories are included in your package. Check to see if they are enclosed with the monitor. If anything is missing or damaged, please contact your local iiyama dealer or regional iiyama office.

- | | | |
|------------------------|---------------------------|---------------------|
| ■ Power Cable * | ■ HDMI Cable | ■ DisplayPort Cable |
| ■ USB Cable (Type-C-C) | ■ USB Cable (Type-A-B) | ■ VESA Plate |
| ■ Stand-Neck | ■ Stand-Base with a screw | ■ Screwdriver |
| ■ Safety Guide | ■ Quick Start Guide | |

CAUTION * All guarantees and warranties are void for any problems or damage caused by a power cable not supplied by iiyama.

An approved power cable greater or equal to H05VVf, 3G, 0.75mm² must be used.

USING ARM OR STAND

CAUTION

- This product is designed for desktop use, not for digital signage (electronic signboard) applications such as ceiling hanging or wall mounting.
- Before installation, make sure the display arm or desk arm stand is strong enough to hold the necessary weight of the monitor and the mount.
- Panel angle adjustment range : 23° upward and 5° downward
- This product cannot be used with the monitor screen facing downward/upward.

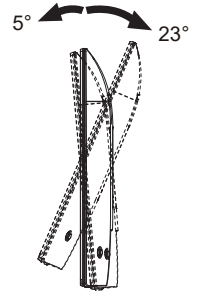

< DISPLAY ARM OR DESK ARM STAND >

CAUTION

When you use with the display arm or desk arm stand, in consideration of thickness of the mounting stage, tighten the M4 Screws (4pcs) which "L" length is 10mm to fasten the monitor. Using the screw longer than this may cause electric shock or damage because it may contact with the electrical parts inside the monitor.

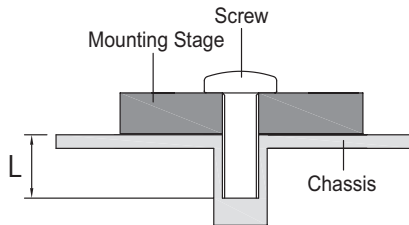

< ROTATING THE MONITOR >

The monitor is designed to be compatible with both landscape and portrait modes. Portrait display must be adjusted using the display settings of the connected device.

ENGLISH

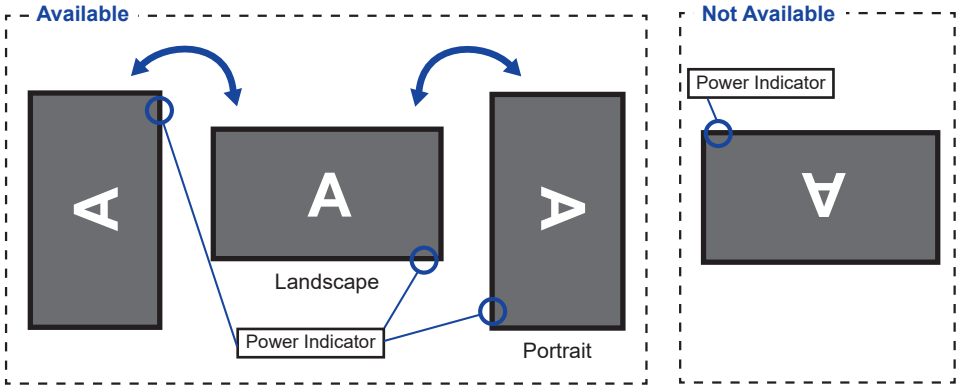

With Stand:

NOTE

- Adjust the monitor's height before panel rotation.
- Attempting to rotate the panel forcibly without adjusting the stand height may cause damage to the panel or the stand.

FITTING AND REMOVAL OF STAND

CAUTION

- Put the monitor on a stable surface. The monitor may cause injury or damage if it falls or is dropped.
- Do not give a strong impact to the monitor. It may cause damage.
- Unplug the monitor before removal or installation to avoid an electric shock or a damage.

<Installation>

- ① Attach the Stand-Neck to the VESA Plate and then tighten the 'thumb screw' with the provided screwdriver to secure them.

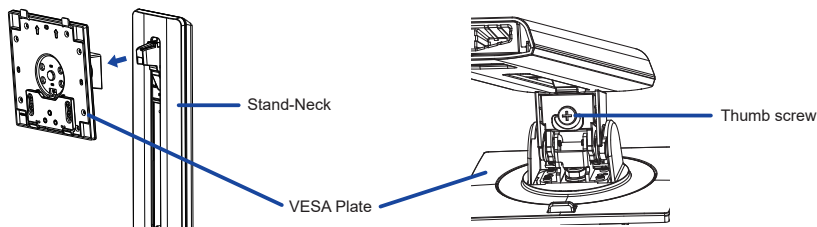

- ② Install the Stand-Neck to the Stand-Base and then tighten the 'thumb screw' to secure them.

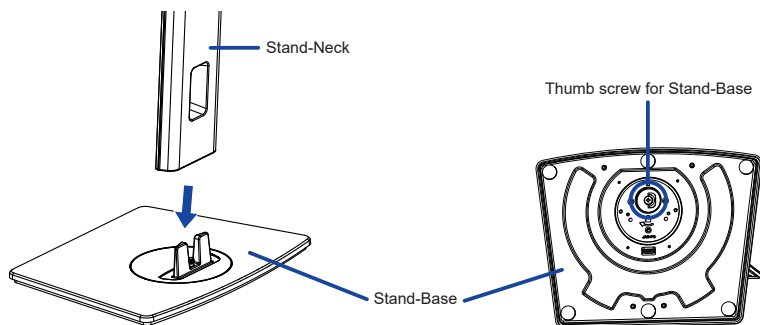

- ③ Put a piece of soft cloth on the table beforehand to prevent the monitor from being scratched. Lay the monitor flat on a table with front face down.
- ④ Hold the monitor and install the assembled stand to the monitor until it clicks to secure.

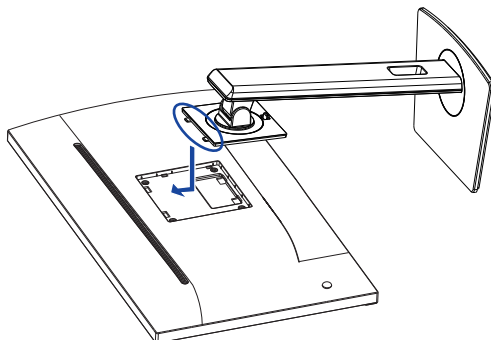

<Removal>

- ① Put a piece of soft cloth on the table beforehand to prevent the monitor from being scratched. Lay the monitor flat on a table with front face down.
- ② Press the Release Button to remove the stand.

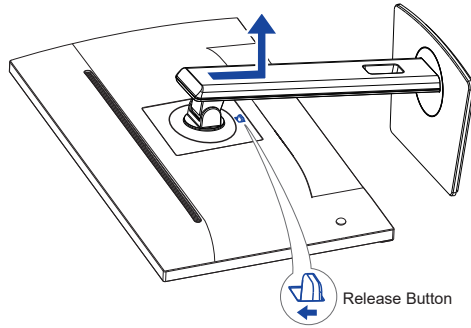

- ③ Loosen the 'thumb screw' with the provided screwdriver to remove the Stand-Neck from the VESA Plate.
- ④ Loosen the 'thumb screw' to remove the Stand-Base from the Stand-Neck.

CONTROLS AND CONNECTORS

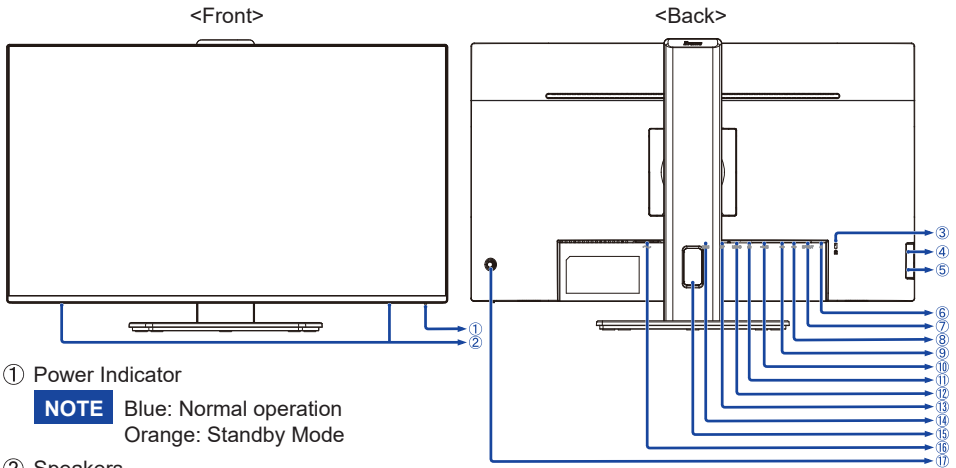

- ① Power Indicator

NOTE Blue: Normal operation
Orange: Standby Mode

- ② Speakers

- ③ Keyhole for Security Lock

NOTE You can fasten a security lock and cable to prevent the monitor from being removed without your permission.

- ④ USB Type-A Downstream Connector (USB3.2 Gen 1: 5Gbps, 5V, 900mA)

- ⑤ USB Type-A Downstream Connector (USB3.2 Gen 1: 5Gbps, 5V, 900mA)

- ⑥ Headphone Connector ()

NOTE Proper operation of connected external devices other than headphones is not guaranteed.

- ⑦ DisplayPort Out Connector (DP OUT) *1

- ⑧ USB Type-C Downstream Connector (USB3.2 Gen 1: 5Gbps, 5V, 3A)

- ⑨ USB Type-A Downstream Connector (USB3.2 Gen 1: 5Gbps, 5V, 900mA)

- ⑩ USB Type-B Upstream Connector ()

- ⑪ LAN(RJ45) Connector ()

- ⑫ USB Type-C Upstream Connector (USB C USB3.2 Gen 1: 5Gbps, 20V, 4.8A)

- ⑬ DisplayPort Connector (DP)

- ⑭ HDMI Connector (HDMI)

- ⑮ Cable Hole

- ⑯ AC Connector (~ : Alternating current)

- ⑰ Joystick / Power Button

[Center] Power / Menu

NOTE A short press turns ON the monitor.
A long press for 6 seconds turns OFF the monitor.

[↑] Up / Input Select **Direct**

[↓] Down

*2 [↔] Right / Volume / Mute Audio **Direct**

*2 [←] Left / Submenu **Shortcut**

*1 DP OUT Connector has a black rubber cap already attached. Remove the cap before connection.

*2 Direction when viewing the screen from the front

CONNECTING YOUR MONITOR

- ① Ensure that both the computer and the monitor are switched off.
- ② Connect the computer to the monitor with the signal cable.
- ③ Connect the computer to the monitor with the USB Cable (Type-A-B).
- ④ Connect the computer to the monitor with the USB Cable (Type-C-C) when viewing images on your monitor through the USB Type-C Connector (USB C) or when using the monitor's USB hub function.*
- ⑤ Connect the Power Cable to the monitor first and then to the power source.
- ⑥ Turn on your monitor and computer.

* ● When charging connected device via USB Type-C Connector (USB C), check if the device is equipped with a USB Type-C connector that supports charging function via USB PD (=Power Delivery).

- The connected device can be charged via USB Type-C Connector even when the monitor is in standby mode. See page 21 for USB Battery Charge (USB BC) function.
- The USB power delivery is up to 96W. If the connected device required more than 96W for operation or for boot up (when the battery is drained), use the original power adapter that came with the device.
- If a separately purchased USB Type-C cable is used, make sure the cable is certified by USB-IF and is full-featured with power delivery and video / audio / data transfer functions.
- If the monitor is in standby mode, it will not display a picture automatically in the following situations:
 1. First boot of the PC
 2. When the PC is resuming from standby modeTo display a picture, tilt the Joystick [⇩]. This is normal behaviour to minimize power consumption during standby mode. To prevent this behaviour, please access the OSD menu and set "USB BC" to "ON".
- USB cable (Type-A-C) is not included with the monitor. If you use a USB cable (Type-A-C), please note that you can only transfer data.
- Compatibility with all connected devices is not guaranteed due to different user environments.

NOTE

- Make sure that the building installation has a circuit breaker of 120/240V, 20A (maximum).
- The signal cables used for connecting the computer and monitor may vary with the type of computer used. An incorrect connection may cause serious damage to both the monitor and the computer. The cable supplied with the monitor is for a standard connector. If a special cable is required please contact your local iiyama dealer or regional iiyama office.
- The Class I pluggable equipment Type A must be connected to protective earth.
- The socket-outlet shall be installed near the equipment and shall be easily accessible.
- Excessive sound pressure from ear-/headphones can cause hearing damage/hearing loss.

[Example of Connection]

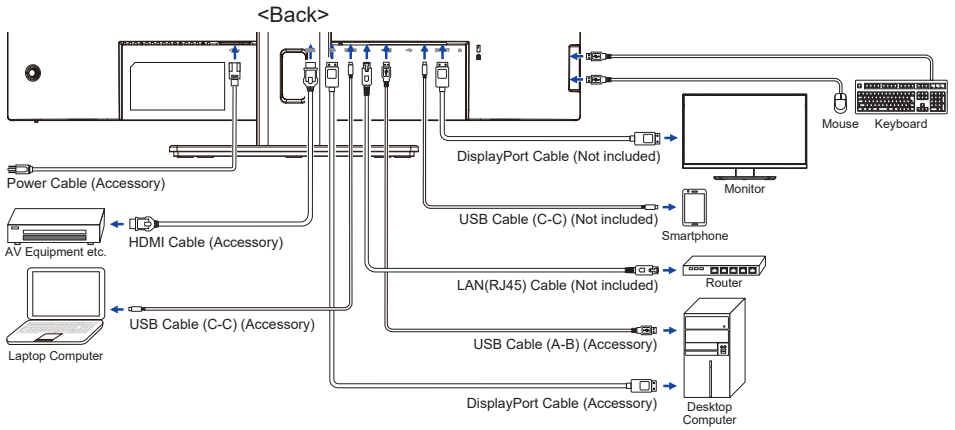

[Collect Cables]

Put the cables through the cable hole to bundle them.

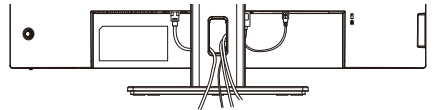

DISCONNECTING YOUR MONITOR

- ① Ensure that both the computer and the monitor are switched off.
- ② Disconnect the power source first and then the Power Cable from the monitor.
- ③ Disconnect the USB cable from the computer and the monitor.
- ④ Disconnect the signal cable from the computer and the monitor.

COMPUTER SETTING

- Signal Timing
Change to the desired signal timing listed on page 31: COMPLIANT TIMING.

ADJUSTING THE HEIGHT AND THE VIEWING ANGLE

- For optimal viewing it is recommended to position yourself directly opposite to the full face of the monitor, then adjust the monitor's height and angle to your own preference.
- Hold the panel so that the monitor does not topple when you change the monitor's height or angle.
- You are able to adjust the monitor's height up to 150mm, angle up to 45° right and left, 23° upward and 5° downward.

- NOTE**
- Do not touch the LCD screen when you change the height or the angle. It may cause damage or break the LCD screen.
 - Careful attention is required not to pinch your fingers or hands into the moving part of the stand when you change the height or the angle.
 - Injury can occur if care is not taken to avoid finger contact with the displays base when adjusting the height.

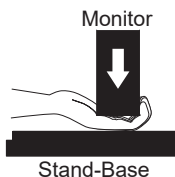
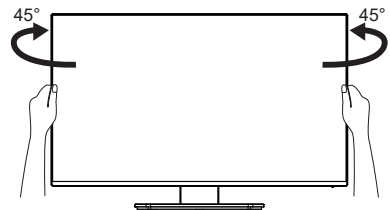
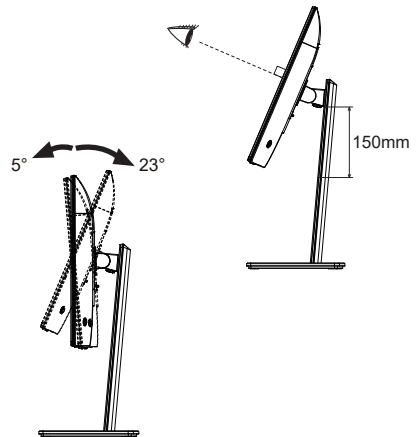

OPERATING THE MONITOR

To create the best picture, your iiyama LCD monitor has been preset at the factory with the COMPLIANT TIMING shown on page 31. You are also able to adjust the picture by following the operation shown below.

- 1 Press the Joystick [Center] on the monitor to start the On Screen Display feature. There are additional Menu items which can be switched by tilting the Joystick [↔/↕].



- 2 Select the Menu item which contains the adjustment icon relating to the adjustment you want to make. Press the Joystick. Then, tilt the Joystick [↕/↔] to highlight the desired adjustment icon.
- 3 Press the Joystick again. Tilt the Joystick [↔/↕] to make the appropriate adjustment or setting.
- 4 Press the Joystick and then tilt it [↔] to leave the menu, and the settings you just made would be automatically saved.

For example, to correct for OSD vertical position, select Menu item of **OSD** and then press the Joystick. Then, select **OSD Vertical Position** by tilting the Joystick [↕/↔].

An adjustment scale becomes active after you press the Joystick. Then, tilt the Joystick [↔/↕] to change the OSD vertical position settings. The OSD vertical position of the overall display should be changing accordingly while you are doing this.

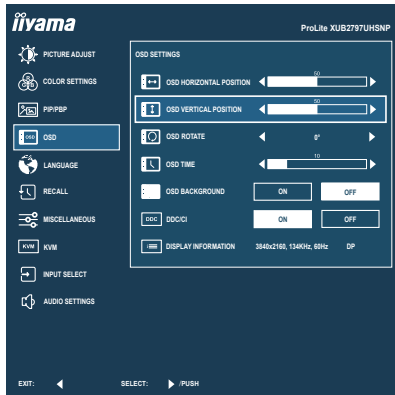

Press the Joystick and finally tilt it [↔] to close the On Screen Display feature. All changes are saved in the memory.

NOTE

- When the Joystick operations are aborted during adjustment, On-Screen Display disappears when the time set for the **OSD Time** has passed. Also, tilting the Joystick [↔] can be used to return to the previous step and turn off the On Screen Display.
- Any changes are automatically saved in the memory when the On Screen Display disappears. Turning off the power should be avoided while using the Menu.

ADJUSTMENT MENU CONTENTS



Picture Adjust *1

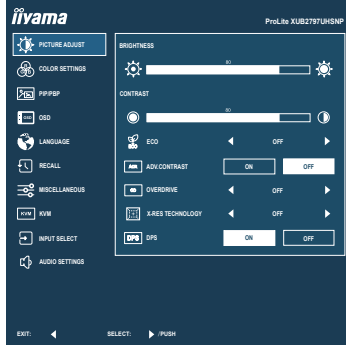

Adjustment Item	Problem / Option		Joystick
Brightness *2	Too dark Too bright		
Contrast	Too dull Too intense		
Eco	Off	Normal	
	Mode 1	Brightness of backlight is reduced.	
	Mode 2	Brightness of backlight is reduced more than Mode 1.	
	Mode 3	Brightness of backlight is reduced more than Mode 2.	
Adv. Contrast	On	Increased Contrast Ratio	
	Off	Typical Contrast Ratio	
Overdrive	Off / 1 / 2 / 3 / 4 / 5 Improves the gray level response time of the LCD panel. A higher level results in a faster response time.		
X-Res Technology	Off	Normal	
	Soft	Enhance the picture edge.	
	Middle	Enhance the picture edge more than the Soft option.	
	Hard	Enhance the picture edge more than the Middle option.	
DPS	On	Dynamic Power Saving is activated and the backlight brightness is reduced.	
	Off	Dynamic Power Saving is disabled.	

NOTE This monitor features an eco-friendly design with DPS function. The default is “On” and the screen may become slightly dark. In that case, select “Off” to obtain the optimal brightness.

*1 Selected adjustments and settings may not be possible due to other items that are enabled. See page 15 **Function Correlation Matrix** for more details.

*2 Adjust the “Brightness” when you are using the monitor in a dark room and feel the screen is too bright.

Shortcut

You can take a shortcut to the specific menu by the following operations.

- Eco : Tilt the Joystick [↵] with no Menu displayed and select “Eco”.

■ Function Correlation Matrix

Active item Selected item	Picture Adjust		Color Settings		PIP/PBP
	Eco	Adv.Contrast	i-Style Color Standard Game Cinema Scenery Text	Blue Light Reducer	PiP PbP LR
Brightness	–	–	–	✓	✓
Contrast	✓	–	–	✓	✓
Eco	–	–	–	–	✓
Adv. Contrast	–	–	–	–	–
Overdrive	✓	✓	✓	✓	✓
X-Res Technology	✓	✓	✓	✓	✓
DPS	–	–	–	–	–

✓ : Available

– : Not available

Color Settings

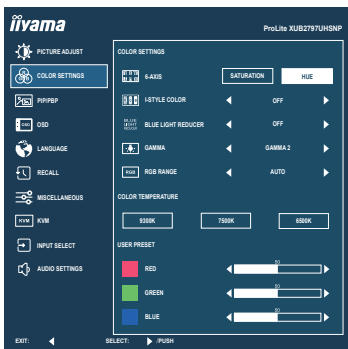

Adjustment Item		Problem / Option		Joystick
6-Axis *1,2	Saturation	Red	Too weak Too strong	
		Yellow		
		Green		
		Cyan		
		Blue		
		Magenta		
	Hue	Red	Too weak Too strong	
		Yellow		
		Green		
		Cyan		
		Blue		
		Magenta		
i-Style Color *1	Off	Return to a state set by color adjustment except i-Style Color.		
	Standard	For general windows environment and monitor default setting		
	Game	For PC game environment		
	Cinema	For movie and video environment		
	Scenery	For displaying outdoor scenery images		
	Text	For text editing and viewing in a word processing environment		
	Shortcut			
Blue Light Reducer *2	Off	Typical		
	Mode 1	Blue light is reduced.		
	Mode 2	Blue light is reduced more than Mode 1.		
	Mode 3	Blue light is reduced more than Mode 2.		
Gamma *2	Gamma 1			
	Gamma 2			
	Gamma 3			
RGB Range	Auto	Automatically select color scale signal.		
	Full	For full-range color scale signal		
	Limited	For limited color scale signal		



Color Settings

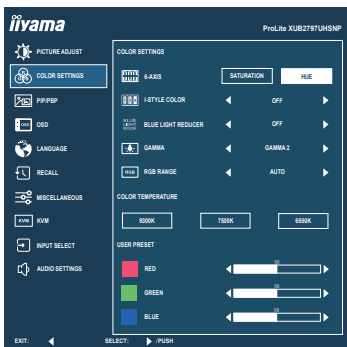

Adjustment Item	Problem / Option	Joystick	
Color Temperature * ¹	9300K	Cool color	
	7500K	Normal color	
	6500K	Warm color	
User Preset * ¹	Red		
	Green		Too weak
	Blue		Too strong

*¹ Disabled when “Blue Light Reducer” is activated.

*² Disabled when “i-Style Color” is activated.

Shortcut

You can take a shortcut to the specific menu by the following operations.

- i-Style Color : Tilt the Joystick [↵] with no Menu displayed and select “i-Style Color”.
- Blue Light Reducer : Tilt the Joystick [↵] with no Menu displayed and select “Blue Light Reducer”.



PIP/PBP *1

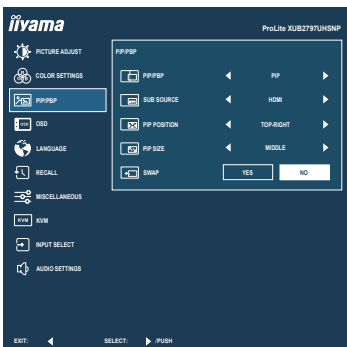









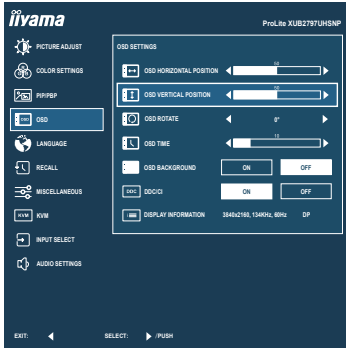







Adjustment Item	Option	
PIP/PBP	Off	PIP/PBP function is turned off.
	PiP	Display the sub screen in the main screen.
	PbP LR	Display the main screen on the left and the sub screen on the right.
Sub Source *2	HDMI	Select the HDMI input for the sub screen.
	DP	Select the DisplayPort input for the sub screen.
	USB C	Select the USB Type-C input for the sub screen.
PiP Position *3	Top-Right	Move the sub screen to the top right corner.
	Bottom-Right	Move the sub screen to the bottom right corner.
	Bottom-Left	Move the sub screen to the bottom left corner.
	Top-Left	Move the sub screen to the top left corner.
PiP Size *3	Small	Reduce the size of the Sub screen.
	Middle	Normal size of the Sub screen
	Large	Increase the size of the Sub screen.
Swap *2	Yes	Swap the Main/Sub screens.
	No	Return to normal.

*1 PIP = Picture in Picture, PBP = Picture by Picture
Disabled when “MST” is activated.

*2 Available in “PiP” or “PbP LR” mode.

*3 Available only in “PiP” mode.



Adjustment Item	Problem / Option	Joystick
OSD Horizontal Position	OSD is too left OSD is too right	   
OSD Vertical Position	OSD is too low OSD is too high	   
OSD Rotate *	Rotates the OSD. 0° / +90° / -90°	   
OSD Time	You can set the OSD display duration time between 5 and 60 seconds.	   
OSD Background	On	Make OSD background transparent.
	Off	Return to normal.
DDC/CI	On	Enable DDC/CI function.
	Off	Disable DDC/CI function.
Display Information	Displays information regarding the current input signal coming from the graphics card in your computer. NOTE See your graphics card user guide for more information about changing the resolution and refresh.	

* +90°: Appropriate for portrait mode with the monitor rotated to the right.

-90°: Appropriate for portrait mode with the monitor rotated to the left.

 Language

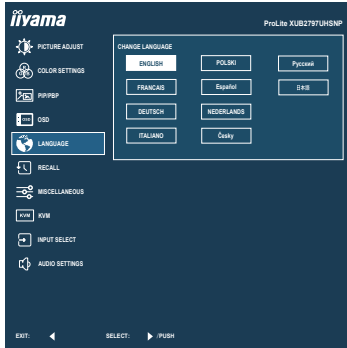

Adjustment Item	Option			
Language	English	English	Español	Spanish
	Français	French	Nederlands	Dutch
	Deutsch	German	Český	Czech
	Italiano	Italian	Русский	Russian
	Polski	Polish	日本語	Japanese

 Recall



Adjustment Item	Option
Recall	Factory-preset data is restored.



Miscellaneous

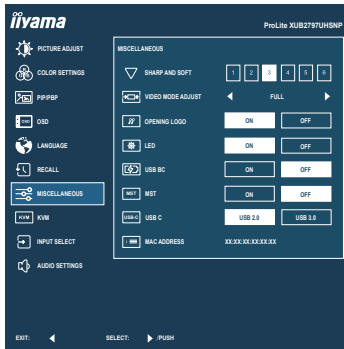



Adjustment Item	Option	Joystick
Sharp and Soft	1 2 3 4 5 6 You can change the picture quality from 1 to 6 (sharp to soft). Tilt [↔] to change the picture quality in numerical order. Tilt [↔] to change the picture quality in reverse numerical order.	
Video Mode Adjust *1	Full	Full screen display
	Aspect	Expansion display of Aspect
	Dot by Dot	Display the picture dot by dot.
Opening Logo	On	iiyama Logo is displayed when the monitor is turned on.
	Off	iiyama Logo is not displayed when the monitor is turned on.
LED	On	The Power Indicator is turned On.
	Off	The Power Indicator is turned Off.
NOTE Turn Off the Power Indicator when you are bothered by the light.		
USB BC	On	USB devices can be charged even when the monitor is in the standby mode.
	Off	USB devices can not be charged when the monitor is in the standby mode.
NOTE When the monitor is turned off, USB devices cannot be charged even when the USB BC function is on. While this function is off, USB devices do not operate even when the monitor is in standby mode to save standby electricity. When operating USB devices, turn this function on.		
MST *1,2,3,4	On	Video signal from computer can be extended on multiple monitors.
	Off	Video signal from computer is cloned on the other monitor.
USB C	USB 2.0	Select the data transfer speed when connecting via USB Type-C.
	USB 3.0	
MAC Address *5	Displays the LAN MAC address.	

- *1 Disabled when “PIP/PBP” is activated.
- *2 Available for DisplayPort or USB Type-C input only.
- *3 On/Off of the “MST” function is not dependent on input signal switching.
- *4 Maximum monitor quantity that can be connected in a daisy chain using DP OUT connector

Input source	MST : On Extension mode	MST : Off Clone mode
Video format	3840 × 2160 @30Hz	3840 × 2160 @60Hz
USB Type-C	2	2
DisplayPort	2	2

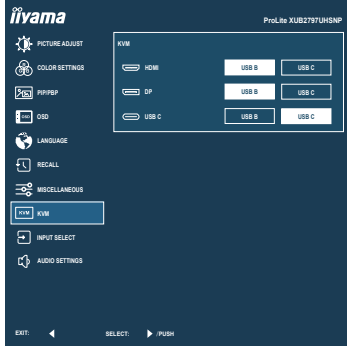
- Total number of monitors including the first one connected directly to the computer
- Connected monitor quantity may differ depending on the specification of the computer used.
- **2×3840×2160 @30Hz in “MST” mode is only available when “USB C” is set to “USB 2.0”.**
- *5 MAC address pass-through is not supported.



Adjustment Item	Option		
KVM	HDMI	USB B	Two computers connected to one monitor's USB Upstream Connectors can share the keyboard and mouse connected to that monitor. USB B: Link the input source with “  ” Connector. USB C: Link the input source with “USB C” Connector.
		USB C	
	DP	USB B	
		USB C	
	USB C	USB B	
		USB C	

NOTE How to check which USB input currently has “KVM” enabled
 When “PbP LR” is activated, tilt the Joystick [↕] once to display “USB B” or “USB C” on the screen where KVM is enabled.
 Tilt the Joystick [↕] again to enable KVM on the other USB input.

Input Select
Direct



Adjustment Item		Option	
Input Source	Auto	Search for an available input source and select automatically.	
	Manual	HDMI	Select the HDMI input.
		DisplayPort	Select the DisplayPort input.
		USB C	Select the USB Type-C input.
		DisplayPort Mode	1.2
1.1	Set the version 1.1 of the DisplayPort.		

NOTE

“Auto” function enables automatic selection of the input sources available. The input source from the computer in standby mode can not be selected. If you manually select one of the input sources, the other source is not automatically selected.

Direct

You can skip the Menu items and directly display an option setting screen by the following operations.

- Input Select : Tilt the Joystick [⇩] with no Menu displayed.

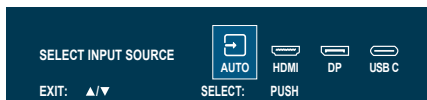



Adjustment Item	Problem / Option		Joystick
Volume Direct	Too soft Too loud		
Mute Audio Direct	On	Turn off the sound temporarily.	
	Off	Return the sound volume to the previous level.	
Audio Input *	HDMI	Switch the audio input to HDMI.	
	DP	Switch the audio input to DisplayPort.	
	USB C	Switch the audio input to USB Type-C.	

* Available only when “PIP/PBP” is activated.

Direct

You can skip the Menu items and directly display an option setting screen by the following operations.

- Volume : Tilt the Joystick [↔] with no Menu displayed.
- Mute Audio : Tilt the Joystick [↔] for 3 seconds with no Menu displayed.

■ Lock Mode

<OSD Menu>

The OSD can be locked to avoid an accidental setting change.

1. Make sure the monitor is turned ON.
2. The OSD lock will be activated by tilting the Joystick [↕] for about 10 seconds. If you try to access the OSD by the Joystick, a message "OSD LOCKED" will appear on the screen.
3. The OSD lock will be deactivated by tilting the Joystick [↕] again for about 10 seconds.

<Power Button Function>

The Power Button function can be locked to avoid an accidental power operation.

1. Make sure the monitor is turned ON.
2. The Power Button function will be locked by tilting the Joystick [↕] for about 10 seconds. If you try to turn off the monitor by pressing the Joystick, a message "POWER BUTTON LOCKED" will appear on the screen.
3. The Power Button function will be unlocked by tilting the Joystick [↕] again for about 10 seconds.

STANDBY FEATURE

This product features the standby function. When activated, it automatically reduces unnecessary power consumption of the monitor when your computer is not in use.

There is a standby step the monitor takes as described below. The standby function, including any timer settings is configured by the operating system. Check your operating system manual for information on how this can be configured.

■ Standby Mode

When the video signal from the computer is off, the monitor enters into Standby Mode which reduces the power consumption to 0.5W or less*. The screen becomes dark, and the power indicator turns to orange. From Standby Mode, the image reappears in several seconds when either the keyboard or the mouse are touched again.

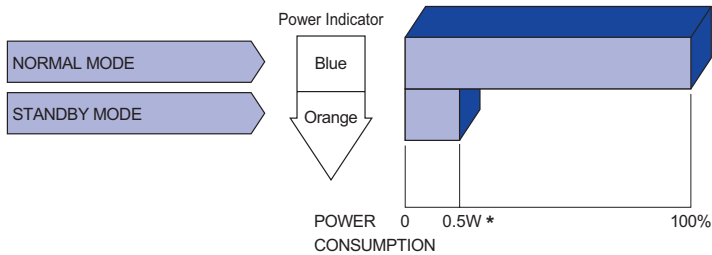

* When the USB devices are not connected.

TROUBLE SHOOTING

If the monitor fails to operate correctly, please follow the steps below for a possible solution.

1. Perform the adjustments described in OPERATING THE MONITOR, depending on the problem you have. If the monitor does not get a picture, skip to 2.
2. Consult the following items if you cannot find an appropriate adjustment item in OPERATING THE MONITOR or if the problem persists.
3. If you are experiencing a problem which is not described below or you cannot correct the problem, discontinue using the monitor and contact your dealer or iiyama service center for further assistance.

Problem

Check

- ① The picture does not appear.

(Power indicator does not light up.)

(Power indicator is blue.)

(Power indicator is orange.)

- ② The screen is not synchronized.

- ③ The screen position is not in the center.

- ④ The screen is too bright or too dark.

- ⑤ The screen is shaking.

- ⑥ No sound.

- ⑦ The sound is too loud or too quiet.

The Power Cable is firmly seated in the socket.

The Power Button is turned ON.

The AC socket is live. Please check with another piece of equipment.

If the blank screen saver is in active mode, touch the keyboard or the mouse.

Increase the Contrast and/or Brightness.

The computer is ON.

The Signal Cable is properly connected.

The signal timing of the computer is within the specification of the monitor.

If the monitor is in standby mode, touch the keyboard or the mouse.

The computer is ON.

The Signal Cable is properly connected.

The signal timing of the computer is within the specification of the monitor.

The Signal Cable is properly connected.

The signal timing of the computer is within the specification of the monitor.

The signal timing of the computer is within the specification of the monitor.

The video output level of the computer is within the specification of the monitor.

The power voltage is within the specification of the monitor.

The signal timing of the computer is within the specification of the monitor.

The audio equipment (computer etc.) is ON.

The Volume is turned up.

The Mute is OFF.

The audio output level of the audio equipment is within the specification of the monitor.

The audio output level of the audio equipment is within the specification of the monitor.

RECYCLING INFORMATION

For better environment protection please don't dispose your monitor.
Please visit our web site: <https://iiyama.com> for monitor recycling.

APPENDIX

Design and specifications are subject to change without prior notice.

SPECIFICATIONS : ProLite XUB2797UHSNP-B1

ENGLISH

Size Category	27"	
LCD Panel	Panel technology	IPS (In-Plane-Switching)
	Size	Diagonal: 27" (68.5cm)
	Pixel pitch	0.155mm H × 0.155mm V
	Brightness	350cd/m ² (Typical), 180cd/m ² (Default / Energy Saving)
	Contrast ratio	1300 : 1 (Typical), Adv. Contrast Function Available
	Viewable angle	Right / Left: 89° each, Up / Down: 89° each (Typical)
	Response time	4ms (Gray to Gray)
Display Colors	Approx. 1.07 Billion	
Sync Frequency	Horizontal: 30.0-140.0kHz, Vertical: 40-60Hz	
Native Resolution	3840 × 2160, 8.3 MegaPixels	
Support max. resolution	HDMI: 3840 × 2160, 60Hz DisplayPort: 3840 × 2160, 60Hz USB Type-C: DP Alt mode 3840 × 2160, 60Hz	
Input Connector	HDMI, DisplayPort, USB Type-C	
Input Video Signal	HDMI, DisplayPort, USB Type-C (DP Alt mode)	
USB Standard	USB3.2 Gen 1 (5Gbps), USB Power Delivery (96W)	
Number of USB Ports	2 Upstream: Type-B, Type-C	
Connector shape	4 Downstream: Type-A (DC5V, 900mA) × 3, Type-C (DC5V, 3A) × 1	
LAN Port	RJ45	
Output Video Connector	DisplayPort	
Headphone Connector *1	ø 3.5mm mini jack (Stereo)	
Speakers	2W × 2 (Stereo speakers)	
Maximum Screen Size	596.7mm W × 335.7mm H / 23.5" W × 13.2" H	
Power Source	100-240VAC, 50/60Hz, 2.3A	
Power Consumption *2	33W typical Standby mode: 0.5W maximum, Off mode: 0.3W maximum	
Dimensions	614.5 × 397.5 - 547.5 × 209.5mm / 24.2 × 15.6 - 21.6 × 8.2" (W×H×D)	
Net Weight	6.7kg / 14.8lbs	
Height Adjustment Range	150mm	
Angle	Tilt: Upward: 23°, Downward: 5° Swivel: Left / Right: 45° each Rotation: Clockwise / Counterclockwise: 90° each	
Environmental Considerations	Operating: Temperature 5 to 35°C / 41 to 95°F Humidity 10 to 80% (No condensation) Storage: Temperature -20 to 60°C / -4 to 140°F Humidity 10 to 90% (No condensation)	
Approvals	TCO Certified, CE, UKCA, TÜV-GS, EAC, VCCI, PSE	

NOTE *1 Proper operation of connected external devices other than headphones is not guaranteed.

*2 When the USB devices are not connected.

DIMENSIONS

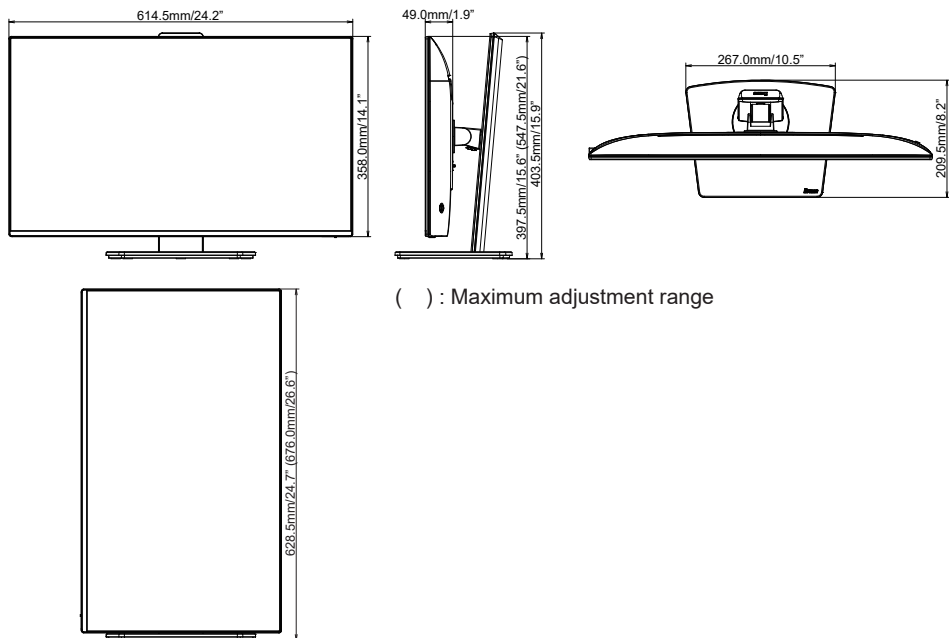

COMPLIANT TIMING

Video Mode	Horizontal Frequency	Vertical Frequency	Dot Clock
800 × 600	37.879kHz	60.317Hz	40.000MHz
1024 × 768	48.363kHz	60.004Hz	65.000MHz
1280 × 1024	63.981kHz	60.020Hz	108.000MHz
1920 × 1080	67.500kHz	60.000Hz	148.500MHz
1920 × 1200	74.038kHz	59.950Hz	154.000MHz
1920 × 2160	135.000kHz	60.000Hz	297.000MHz
3840 × 2160	67.430kHz	29.970Hz	296.700MHz
	133.313kHz	59.997Hz	533.250MHz
	135.000kHz	60.000Hz	594.000MHz

NOTE * Automatically selected in "PbP LR" mode. If not, you can select it manually.