

# ***USER MANUAL***

# ***G-MASTER***

## **LCD Monitor**

ENGLISH

### ***G-MASTER G3266HS***

Thank you very much for choosing the iiyama LCD monitor.

We recommend that you take a few minutes to read this comprehensive manual carefully before installing and switching on the monitor. Please keep this manual in a safe place for your future reference.



**Dear user, we congratulate you on the purchase of your iiyama LCD.**

For details on warranty and locally used pixel policies that apply directly after installation of your product please check the iiyama website.

**To report a fault, please contact your local support centre found at [www.iiyama.com/service](http://www.iiyama.com/service)**

## Things to check before you call the iiyama information line

- | if the power cable is connected securely and turned on?
- | if the display has been turned on?
- | if the signal cable is connected securely and the correct input selected?
- | if the computer has been restarted with the display connected?
- | if the graphics card is correctly installed with the latest drivers possible?
- | if the correct native resolution has been selected via 'Display Properties'?
- | If the R/G/B signal configuration is correct?
- | if the displays On Screen Menu is shown?
- | if the correct brightness and contrast settings have been set?
- | if given display tolerances and compatibility have been considered?
- | if via the On Screen Menu you have performed a Factory Reset/Recall?

## Before reporting the screen defect, please prepare the following information/evidence:

- | model number \*
- | purchase receipt and serial number \*
- | name and address for collection
- | telephone/fax number, for availability during the day
- | convenient collection date (date, time)
- | short description of the defect

## Important Note:

If there is no fault found in the collected equipment after inspection, the transferring party shall incur charges for transport and administration.

If you have checked all of the above and there is still no picture, call our information line for assistance in your country.

\* see the identification plate on the back of the case.

## CE MARKING DECLARATION OF CONFORMITY

This LCD monitor complies with the requirements of the EC/EU Directive 2014/30/EU "EMC Directive", 2014/35/EU "Low Voltage Directive", 2009/125/EC "ErP Directive" and 2011/65/EU "RoHS Directive".

The electro-magnetic susceptibility has been chosen at a level that gives correct operation in residential areas, business and light industrial premises and small-scale enterprises, inside as well as outside of the buildings. All places of operation are characterised by their connection to the public low voltage power supply system.

IYAMA CORPORATION: Wijkemeerstraat 8, 2131 HA Hoofddorp, The Netherlands

Model No. : PL3266H



We recommend recycling of used product. Please contact your dealer or iiyama service center. Recycle information is obtained via the Internet, using the address:  
<http://www.iiyama.com>

You can access the Web page of different countries from there.

- We reserve the right to change specifications without notice.
- All trademarks used in this user manual are the property of their respective owners.

# TABLE OF CONTENTS

|  |    |
|--|----|
| FOR YOUR SAFETY .....                      | 1  |
| SAFETY PRECAUTIONS.....                    | 1  |
| SPECIAL NOTES ON LCD MONITORS .....        | 3  |
| CUSTOMER SERVICE .....                     | 3  |
| CLEANING .....                             | 3  |
| BEFORE YOU OPERATE THE MONITOR .....       | 4  |
| FEATURES.....                              | 4  |
| CHECKING THE CONTENTS OF THE PACKAGE ..... | 4  |
| WALL MOUNTING .....                        | 5  |
| CONTROLS AND CONNECTORS.....               | 6  |
| CONNECTING YOUR MONITOR.....               | 7  |
| COMPUTER SETTING .....                     | 8  |
| ADJUSTING THE VIEWING ANGLE .....          | 8  |
| OPERATING THE MONITOR.....                 | 9  |
| ADJUSTMENT MENU CONTENTS .....             | 10 |
| SCREEN ADJUSTMENTS .....                   | 16 |
| POWER MANAGEMENT FEATURE.....              | 19 |
| TROUBLE SHOOTING .....                     | 20 |
| RECYCLING INFORMATION.....                 | 21 |
| APPENDIX .....                             | 22 |
| SPECIFICATIONS.....                        | 22 |
| DIMENSIONS.....                            | 23 |
| COMPLIANT TIMING .....                     | 24 |

# FOR YOUR SAFETY

## SAFETY PRECAUTIONS

### WARNING

#### **STOP OPERATING THE MONITOR WHEN YOU SENSE TROUBLE**

If you notice any abnormal phenomena such as smoke, strange sounds or fumes, unplug the monitor and contact your dealer or iiyama service center immediately. Further use may be dangerous and can cause fire or electric shock.

#### **NEVER REMOVE THE CABINET**

High voltage circuits are inside the monitor. Removing the cabinet may expose you to the danger of fire or electric shock.

#### **DO NOT PUT ANY OBJECT INTO THE MONITOR**

Do not put any solid objects or liquids such as water into the monitor. In case of an accident, unplug your monitor immediately and contact your dealer or iiyama service center. Using the monitor with any object inside may cause fire, electric shock or damage.

#### **INSTALL THE MONITOR ON A FLAT, STABLE SURFACE**

The monitor may cause an injury if it falls or is dropped.

#### **DO NOT USE THE MONITOR NEAR WATER**

Do not use where water may be splashed or spilt onto the monitor as it may cause fire or electric shock.

#### **OPERATE UNDER THE SPECIFIED POWER SUPPLY**

Be sure to operate the monitor only with the specified power supply. Use of an incorrect voltage will cause malfunction and may cause fire or electric shock.

#### **PROTECT THE CABLES**

Do not pull or bend the power cable and signal cable. Do not place the monitor or any other heavy objects on the cables. If damaged, the cables may cause fire or electric shock.

#### **ADVERSE WEATHER CONDITIONS**

It is advisable not to operate the monitor during a heavy thunder storm as the continual breaks in power may cause malfunction. It is also advised not to touch the plug in these circumstances as it may cause electric shock.

## CAUTION

### INSTALLATION LOCATION

Do not install the monitor where sudden temperature changes may occur, or in humid, dusty or smoky areas as it may cause fire, electric shock or damage. You should also avoid areas where the sun shines directly on the monitor.

### DO NOT PLACE THE MONITOR IN A HAZARDOUS POSITION

The monitor may topple and cause injury if not suitably located. Please also ensure that you do not place any heavy objects on the monitor, and that all cables are routed such that children may not pull the cables and possibly cause injury.

### MAINTAIN GOOD VENTILATION

Ventilation slots are provided to keep the monitor from overheating. Covering the slots may cause fire. To allow adequate air circulation, place the monitor at least 10 cm (or 4 inches) from any walls. Do not remove the tilt stand when operating the monitor. Ventilation slots on the back of the cabinet will be blocked and the monitor may overheat if the stand is removed. This may cause fire or damage. Operating the monitor on its back, side, upside down or on a carpet or any other soft material may also cause damage.

### DISCONNECT THE CABLES WHEN YOU MOVE THE MONITOR

When you move the monitor, turn off the power switch, unplug the monitor and be sure the signal cable is disconnected. If you do not disconnect them, it may cause fire or electric shock.

### UNPLUG THE MONITOR

If the monitor is not in use for a long period of time it is recommended that it is left unplugged to avoid accidents.

### HOLD THE PLUG WHEN DISCONNECTING

To disconnect the power cable or signal cable, always pull it by the plug. Never pull on the cable itself as this may cause fire or electric shock.

### DO NOT TOUCH THE PLUG WITH WET HANDS

Pulling or inserting the plug with wet hands may cause electric shock.

### WHEN YOU INSTALL THE MONITOR ON YOUR COMPUTER

Be sure the computer is strong enough to hold the weight of the monitor, otherwise, you may damage your computer.

### CAREFUL! PROTECT YOUR HANDS AND FINGERS

- Be careful not to hurt your fingers or hands when you change the height or the angle.
- Injury can occur if care is not taken to avoid finger contact with the displays base when adjusting the height. (Just for height adjustable model.)

### REMARK FOR 24/7 USAGE

This product is not specifically designed for 24/7 usage in all environments.

## OTHERS

### ERGONOMIC RECOMMENDATIONS

To eliminate eye fatigue, do not operate the monitor against a bright background or in a dark room. For optimal viewing comfort, the monitor should be just below eye level and 40-60 cm (16-24 inches) away from your eyes. When using the monitor over a prolonged time, a ten minute break every hour is recommended as looking at the screen continuously can cause eye strain.

## SPECIAL NOTES ON LCD MONITORS

The following symptoms are normal with LCD monitors and do not indicate a problem.

- NOTE**
- When you first turn on the LCD monitor, the picture may not fit in the display area because of the type of computer that is used. In this case, adjust the picture position to the correct position.
  - You may find slightly uneven brightness on the screen depending on the desktop pattern you use.
  - Due to the nature of the LCD screen, an afterimage of the previous screen may remain after switching the image, when the same image is displayed for hours. In this case, the screen can be recovered slowly by changing the image or turning off the Power Switch for some hours.

## CUSTOMER SERVICE

- NOTE**
- If you have to return your unit for service and the original packaging has been discarded, please contact your dealer or iiyama service center for advice or replacement packaging.

## CLEANING

- WARNING**
- If you drop any materials or liquids such as water into the monitor when cleaning, unplug the power cable immediately and contact your dealer or iiyama service center.

- CAUTION**
- For safety reasons, turn off the power switch and unplug the monitor before you clean it.

- NOTE**
- To protect the LCD panel, do not scratch or rub the screen with a hard object.
  - Never use any of the following strong solvents. These will damage the cabinet and the LCD screen.

|                  |                          |
|------------------|--------------------------|
| Thinner          | Spray-type cleaner       |
| Benzine          | Wax                      |
| Abrasive cleaner | Acid or Alkaline solvent |

- Touching the cabinet with any product made from rubber or plastic for a long time may cause degeneration or loss of paint on the cabinet.

**CABINET** Stains can be removed with a cloth lightly moistened with a mild detergent solvent. Then wipe the cabinet with a soft dry cloth.

**LCD** Periodic cleaning with a soft dry cloth is recommended.

**SCREEN** Don't use tissue paper etc. because these will damage the LCD screen.

## BEFORE YOU OPERATE THE MONITOR

### FEATURES

- ◆ Supports Resolutions up to 1920 × 1080
- ◆ High Contrast 3000:1 (Typical), Adv. Contrast Function Available / Brightness 300cd/m<sup>2</sup> (Typical) / Quick Respons Time 3ms (Gray to Gray)
- ◆ Supports AMD FreeSync™ technology (through DisplayPort-input)
- ◆ Flicker - Free
- ◆ Blue Light Reducer
- ◆ Digital Character Smoothing
- ◆ Stereo Speakers  
2 × 2W Stereo Speakers
- ◆ Plug & Play VESA DDC2B Compliant  
Windows® 7/8.1/10 Compliant
- ◆ Power Management (VESA DPMS Compliant)
- ◆ VESA Mounting Standard (100mm×100mm) Compliant
- ◆ Keyhole for Security Lock

### CHECKING THE CONTENTS OF THE PACKAGE

The following accessories are included in your package. Check to see if they are enclosed with the monitor. If anything is missing or damaged, please contact your local iiyama dealer or regional iiyama office.

- |                  |                |                     |
|------------------|----------------|---------------------|
| ■ Power Cable*   | ■ HDMI Cable   | ■ DisplayPort Cable |
| ■ Headphone hook | ■ Safety Guide | ■ Quick Start Guide |

#### CAUTION

\* The rating of the Power Cable enclosed in 120V area is 10A/125V. If you are using a power supply higher than this rating, then a power cable with a rating of 10A/250V must be used. However, all guarantees and warranties are void for any problems or damage caused by a power cable not supplied by iiyama.



## WALL MOUNTING

- WARNING**
- When you use with the wall mounting, in consideration of thickness of the mounting stage, tighten the M4 Screw with washer which “L” length is 9mm to fasten the monitor. Using the screw longer than this may cause electric shock or damage because it may contact with the electrical parts inside the monitor.
  - Please check if the wall or ceiling can support the weight of the monitor before mounting it.

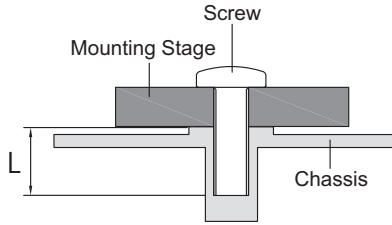

# CONTROLS AND CONNECTORS

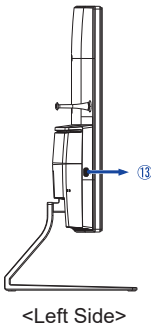
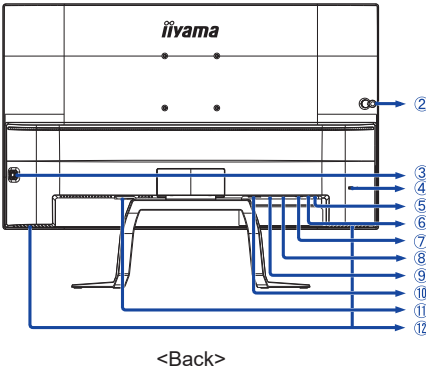
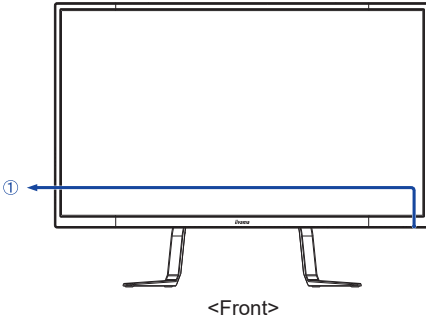

① Power Indicator

**NOTE** White: Normal operation  
Orange: Power Management

② Headphone hook\*

③ Navigation Button

Power Switch / Menu

Scroll Up ( ▲ )

Scroll Down / ECO Mode ( ▼ )

Left / Input Select ( ◀ )

Right / Audio Adjust ( ▶ )

④ Keyhole for Security Lock

**NOTE** You can fasten a security lock and cable to prevent the monitor from being removed without your permission.

⑤ Headphone Connector ( ♂ )

⑥ Audio Connector ( ⚡ )

⑦ VGA Connector ( D-SUB )

⑧ DisplayPort Connector ( DP )

⑨ HDMI Connector ( HDMI )

⑩ DVI-D Connector ( DVI )

⑪ AC Connector ( ~ : Alternating current ) ( ~ )

⑫ Speakers

⑬ USB(Battery Charger) Connector ( ⚡ )

\* If necessary, install the included Headphone hook, turn and secure it.

## CONNECTING YOUR MONITOR

- ① Ensure that both the computer and the monitor are switched off.
- ② Connect the computer to the monitor with the signal cable.
- ③ Connect the monitor to the audio equipment with the Audio Cable for computer when using the audio features.
- ④ Connect the Power Cable to the monitor first and then to the power supply.
- ⑤ Turn on your monitor and computer.
- ⑥ To turn off your monitor, press and hold the Power Switch for 3 seconds when the menu is not displayed.

### NOTE

- The signal cables used for connecting the computer and monitor may vary with the type of computer used. An incorrect connection may cause serious damage to both the monitor and the computer. The cable supplied with the monitor is for a standard connector. If a special cable is required please contact your local iiyama dealer or regional iiyama office.
- For connection to Macintosh computers, contact your local iiyama dealer or regional iiyama office for a suitable adaptor.
- Make sure you tighten the finger screws at each end of the signal cable.
- The Class I pluggable equipment Type A must be connected to protective earth.
- The socket-outlet shall be installed near the equipment and shall be easily accessible.
- Excessive sound pressure from ear-/headphones can cause hearing damage/hearing loss.

[Example of Connection]

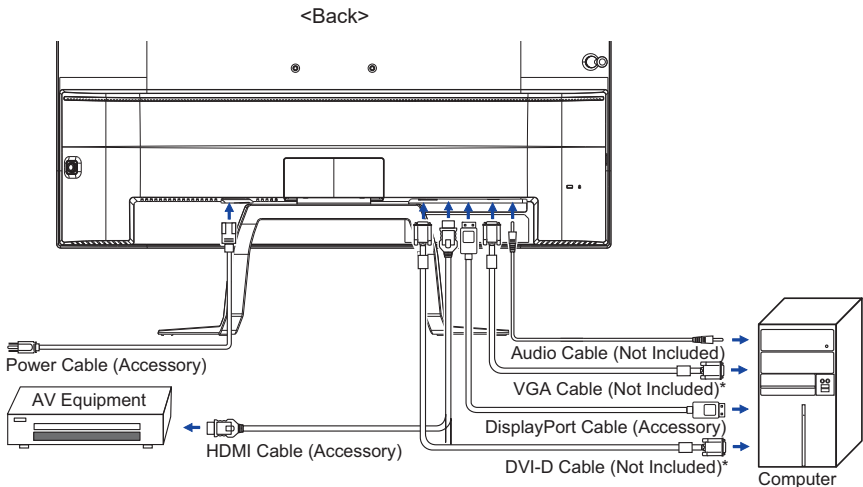

- \* Cable is not supplied with the monitor. If you use low quality Cable, it may cause a result of electro-magnetic interference. Please contact the iiyama Support Centre in your country if you wish to connect the monitor via the VGA or DVI input.

## COMPUTER SETTING

### ■ Signal Timing

Change to the desired signal timing listed on page 24: COMPLIANT TIMING.

## ADJUSTING THE VIEWING ANGLE

- For optimal viewing it is recommended to look at the full face of the monitor.
- Hold the stand so that the monitor does not topple when you change the monitor's angle.
- You are able to adjust the monitor's angle up to 12° upward, 4° downward.
- In order to ensure a healthy and relaxed body position when using the monitor at visual display workstations, it is recommended that the adjusted tilt angle should not exceed 10 degrees. Adjust the monitor's angle to your own preference.

### NOTE

- Do not touch the LCD screen when you change the angle. It may cause damage or break the LCD screen.
- Careful attention is required not to catch your fingers or hands when you change the angle.

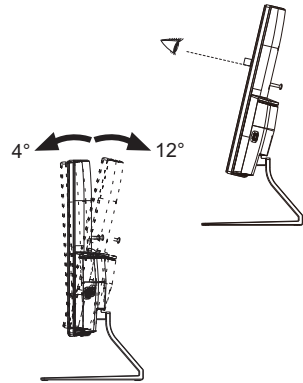

# OPERATING THE MONITOR

To create the best picture, your iiyama LCD monitor has been preset at the factory with the COMPLIANT TIMING shown on page 24. You are also able to adjust the picture by following the button operation shown below. For more detailed adjustments, see page 16 for SCREEN ADJUSTMENTS.

- 1 Press the MENU Button to start the On Screen Display feature. There are additional Menu items which can be switched by using the ▲ / ▼ Buttons.

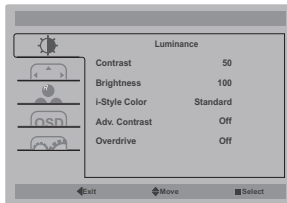

- 2 Select the Menu item which contains the adjustment icon relating to the adjustment you want to make. Press the MENU Button. Then, use the ▲ / ▼ Buttons to highlight the desired adjustment icon.
- 3 Press the MENU Button again. Use the ◀ / ▶ Buttons to make the appropriate adjustment or setting.
- 4 Press the ◀ Button to leave the menu, and the settings you just made would be automatically saved.

For example, to correct for vertical position, select Menu item of Image Setup and then press the MENU Button. Then, select V.Position by using the ▲ / ▼ Buttons.

An adjustment page appears after you press the MENU Button. Then, use the ◀ / ▶ Buttons to change the vertical position settings. The vertical position of the overall display should be changing accordingly while you are doing this.

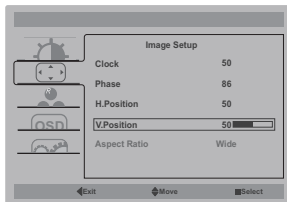









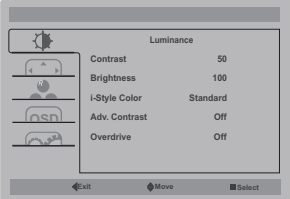



Press the ◀ Button lastly, it ends, all changes are saved in the memory.

## NOTE

- When button operations are aborted during adjustment, On-Screen Display disappears when the time set for the OSD Timeout has passed. Also, the ◀ button can be used to return previous menu and turn off the On-Screen Display.
- Any changes are automatically saved in the memory when the On Screen Display disappears. Turning off the power should be avoided while using the Menu.
- Adjustments for H. / V. Position, Clock and Phase are saved for each signal timing. Except for these adjustments, all other adjustments have only one setting which applies to all signal timings.

## ADJUSTMENT MENU CONTENTS

| Adjustment Item   |  | Problem / Option   | Button to Press  |
|---|--|--|--|
|  <b>Luminance</b>  |  |  |  |
|    |  |  |  |
| Contrast  | Too dull<br>Too intense  |  |  <br>          |
| Brightness * <sup>1</sup>   | Too dark<br>Too bright   |  |  <br>          |
| i-Style Color * <sup>2</sup>  | Standard   | For general windows environment and monitor default setting.   |  |
|   | Text   | For text editing and viewing in a word processing environment. |  |
|   | Internet   | For internet environment.                                      |  |
|   | Game   | For PC game environment.                                       |  |
|   | Movie  | For movie and video environment.                               |  |
| Adv. Contrast   | Off  | Typical Contrast Ratio   |  |
|   | On   | Increased Contrast Ratio                                       |  |
| <p><b>NOTE</b> Adv. Contrast adjusts brightness according to the image, and improve the contrast ratio during movie playing.<br/>           Contrast, Brightness, Color Temp., Eco, i-Style Color and Blue Light Reducer cannot be adjusted and selected while Adv. Contrast is active.</p> |  |  |  |
| Overdrive * <sup>3</sup>  | Off / -2 / -1 / 0 / +1 / +2<br>It will improve the gray level response time of the LCD panel.<br>A higher level results in a faster response time. |  |  <br>  |

\*<sup>1</sup> Adjust the Brightness when you are using the monitor in a dark room and feel the screen is too bright. Brightness adjustment is disabled when Eco is activated.

\*<sup>2</sup> i-Style Color cannot be adjusted and selected while Blue Light Reducer is active.

\*<sup>3</sup> When Overdrive is activated, some level of image retention will be caused.



## Image Setup

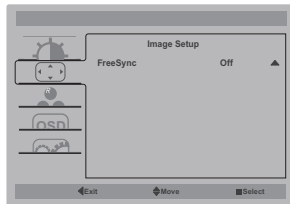
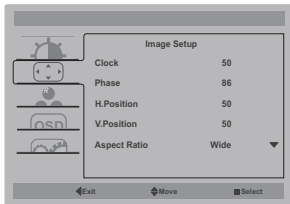

| Adjustment Item | Problem / Option                    | Button to Press                           |
|-----------------|-------------------------------------|---|
| Clock*1,2       | Too narrow                          |   |
|                 | Too wide                            |   |
| Phase*1,2       | To correct flickering text or lines | <br>                                      |
| H. Position*2   | Too left                            |   |
|                 | Too right                           |   |
| V. Position*2   | Too low                             |   |
|                 | Too high                            |   |
| Aspect Ratio    | Wide                                | Expansion display                         |
|                 | 4:3                                 | Displays all picture in 4:3 aspect ratio. |
|                 | 5:4                                 | Displays all picture in 5:4 aspect ratio. |
| FreeSync*3      | Off                                 | The Freesync function is turned off.      |
|                 | On                                  | Enable the Freesync function.             |

\*1 See page 16 for SCREEN ADJUSTMENTS.

\*2 Only Analog Input.

\*3 Only DisplayPort Input.



**Color Temp. \***

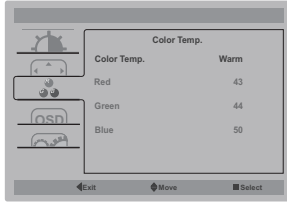

| Adjustment Item | Problem / Option |                 | Button to Press |  |
|-----------------|------------------|-----------------|-----------------|--|
| Color Temp.     | Cool             | Bluish white    |                 |  |
|                 | Normal           | Yellowish white |                 |  |
|                 | Warm             | Greenish white  |                 |  |
|                 | sRGB             | sRGB            |                 |  |
|                 | User             | Red             | Too weak        |  |
|                 |                  | Green           |                 |  |
| Blue            |                  | Too strong      |                 |  |

**NOTE**

- sRGB is an international standard which defines and unifies the difference of color appearance between equipment.
- You can not adjust the Contrast, Brightness, i-Style Color and Eco during sRGB mode because those settings are locked.

\* Color Temp. cannot be adjusted and selected while Blue Light Reducer is active.



**OSD OSD Setup**

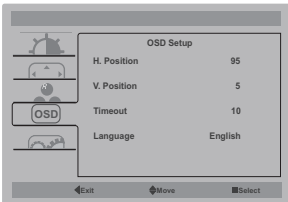

| Adjustment Item | Problem / Option   |            | Button to Press |          |
|-----------------|--|------------|-----------------|----------|
| H. Position     | OSD is too left<br>OSD is too right                                  |            |                 |          |
| V. Position     | OSD is too low<br>OSD is too high                                    |            |                 |          |
| Timeout         | You can set the OSD display duration time between 5 and 100 seconds. |            |                 |          |
| Language        | English  | English    | Italiano        | Italian  |
|                 | Français   | French     | Čeština         | Czech    |
|                 | Español  | Spanish    | Nederlands      | Dutch    |
|                 | Português  | Portuguese | Polski          | Polish   |
|                 | Русский  | Russian    | 日本語             | Japanese |
|                 | Deutsch  | German     |                 |          |

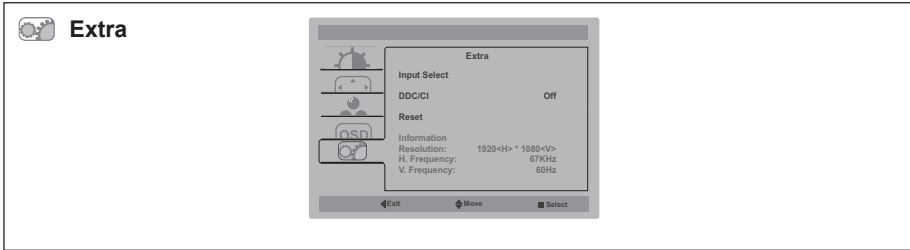

| Adjustment Item            | Problem / Option   |   | Button to Press                         |
|----------------------------|--|---|---|
| Input Select <b>Direct</b> | Input Select   | VGA   | Select the Analog (VGA) input.          |
|                            |  | DVI   | Select the Digital (DVI) input.         |
|                            |  | HDMI  | Select the Digital (HDMI) input.        |
|                            |  | DP  | Select the Digital (DisplayPort) input. |
|                            | Auto-Switch Input  | Off   | Auto-Switch Input is Off.               |
| On                         |  | If there is no signal source at the selected input signal, the input signal with the signal source is automatically selected. |   |
| DDC / CI                   | Off  | DDC / CI is Off.  |   |
|                            | On   | DDC / CI is On.   |   |
| Reset                      | Yes  | Factory-preset data is restored.  |   |
|                            | No   | Return to Menu.   |   |
| Information                | Displays information regarding the current input signal coming from the graphic card in your computer.<br><b>NOTE</b> See your graphic card user guide for more information about changing the resolution and refresh. |   |   |

**Direct**



You can skip the Menu items and display an adjustment scale directly by using the following button operations.

- Input Select: Press the ◀ button when the Menu is not displayed.

## Direct

You can skip the Menu items and display an adjustment scale directly by using the following button operations.

- Audio Adjust: Press the ► Button when the Menu is not displayed.

| Adjustment Item | Problem / Option | Button to Press   |
|-----------------|------------------|---|
| Volume          | Too soft         |   |
|                 | Too loud         |   |
| Audio Source *  | HDMI             | Select the HDMI input.  |
|                 | DP               | Select the DisplayPort input.   |
|                 | Line-In          | Select the Line-In input.   |

\* Suitable for HDMI/DisplayPort input only.

- Auto Configure: Press and hold the ◀ Button for 2-3 seconds when the Menu is not displayed.

### Only Analog Input

| Adjustment Item  | Problem / Option  | Button to Press |
|------------------|---|-----------------|
| Auto Configure * | Adjust H. / V. Position, Clock and Phase automatically. |                 |

\* For best results, use the Auto Adjust in conjunction with the adjustment pattern. See page 16 for SCREEN ADJUSTMENTS.

- Eco \* : Press the ▼ Button when the Menu is not displayed.

Off : Normal

Mode1 : Brightness of back-light is reduced.

Mode2 : Brightness of back-light is reduced more than 1.

Mode3 : Brightness of back-light is reduced more than 2.

\* Eco is disabled when i-Style Color, Adv. Contrast or Color Temp. sRGB is activated.

- Blue Light Reducer \* : Pressing and holding of the ► Button for 3 seconds when the Menu is not displayed.

Off : Normal

Mode1 : Blue light is reduced.

Mode2 : Blue light is reduced more than Mode1.

Mode3 : Blue light is reduced more than Mode2.

\* Blue Light Reducer is disabled when i-Style Color or Color Temp. sRGB is activated.

- OSD Key Lock:

Press and hold the ▼ Button for 2-3 seconds when the Menu is not displayed, it will lock/unlock the OSD Key Lock function.

## SCREEN ADJUSTMENTS

Adjust the image by following the procedure below to get the desired picture when selecting Analog input.

- The screen adjustments described in this manual are designed to set image position and minimize flicker or blur for the particular computer in use.
- The monitor is designed to provide the best performance at resolution of 1920 × 1080, but can not provide the best at resolutions of less than 1920 × 1080 because the picture is automatically stretched to fit the full screen. It is recommended to operate at resolution of 1920 × 1080 in normal use.
- Displayed text or lines will be blurred or irregular in thickness when the picture is stretched due to the screen enlargement process.
- It is preferable to adjust the image position and frequency with the monitor controls, rather than the computer software or utilities.
- Perform adjustments after a warm-up period of at least thirty minutes.
- Additional adjustments may be required after the Auto Image Adjust depending on the resolution or signal timing.
- The Auto Image Adjust may not work correctly when displaying the picture other than the screen adjustment pattern. In this case, manual adjustments are required.

There are two ways to adjust the screen. One way is automatic adjustment for Position, Clock and Phase. The other way is performing each adjustment manually.

Perform the Auto Image Adjust first when the monitor is connected to a new computer, or resolution is changed. If the screen has a flicker or blur, or the picture does not fit in the display area after performing the Auto Image Adjust, manual adjustments are required. Both adjustments should be made by using the screen adjustment pattern (Test.bmp) obtained via the IIYAMA web site (<http://www.iiyama.com>).

Adjust the image by following the procedure below to get the desired picture.

This manual explains adjustment under Windows® OS.

- ① **Display the picture at the optimum resolution.**
- ② **Enter the Test.bmp (screen adjustment pattern) to wallpaper.**

### NOTE

- Consult the appropriate documentation for doing this.
- Test.bmp is made at resolution of 1280 × 1024. Set the display position to center in the wallpaper setting dialogue box.

[Adjustment pattern]

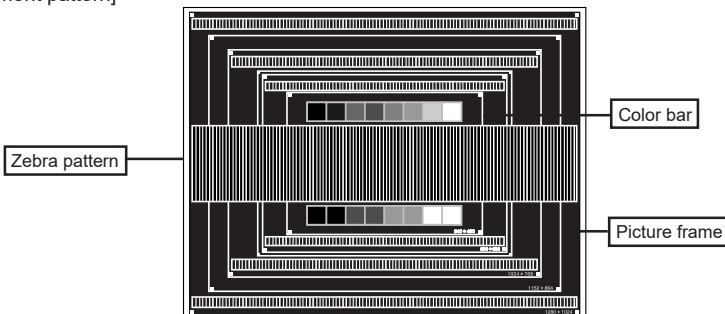

- ③ Pressing and holding of the ◀ Button for about 2-3 seconds. (Auto Configure)
- ④ Adjust the image manually by following procedure below when the screen has a flicker or blur, or the picture does not fit in the display area after performing the Auto Image Adjust.
- ⑤ Adjust the V.Position so that the top and bottom of the picture frame will fit to the display area.

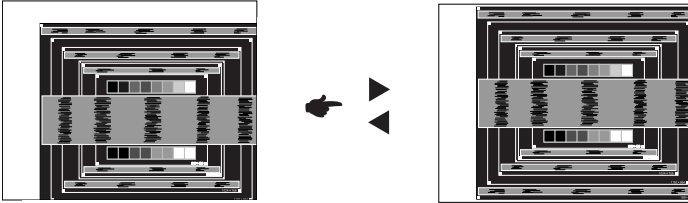

- ⑥ 1) Adjust the H.Position so that the left side of the picture frame will move to the left edge of the display area.

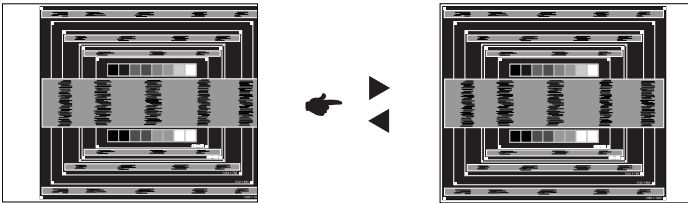

- 2) Stretch the right side of the picture frame to the right edge of the display area by adjusting the Clock.

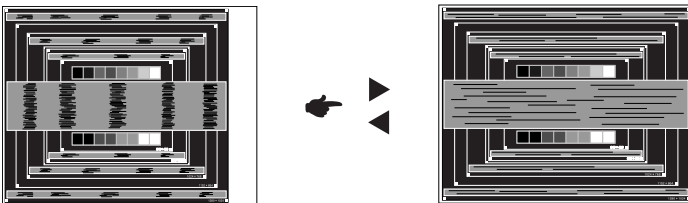
**NOTE**

- When the left side of the picture frame moves apart from the left edge of the display area during the Clock adjustment, adjust steps 1) and 2).
- Another way to make the Clock adjustment is to correct the vertical wavy lines in the zebra pattern.
- The picture may flicker during the Clock, H.Position and V.Position adjustment.
- In case the picture frame is bigger or smaller than the data display area after the Clock adjustment, repeat steps from ③.

- ⑦ Adjust the Phase to correct horizontal wavy noise, flicker or blur in the zebra pattern.

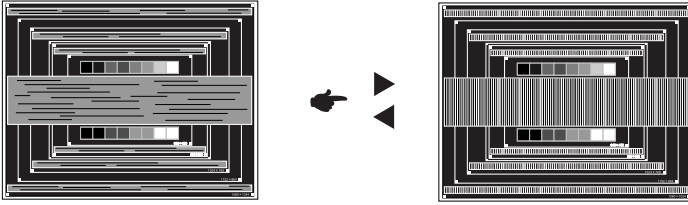
**NOTE**

- In case the strong flicker or blurs remain on a part of the screen, repeat steps ⑥ and ⑦ because the Clock may not be adjusted correctly. If the flicker or blurs still remain, set the refresh rate of computer to low (60Hz) and repeat steps from ③ again.
- Adjust the H.Position after the Phase adjustment if the horizontal position moves during the adjustment.

- ⑧ Adjust the Brightness and Color to get the desired picture after you complete the Clock and Phase adjustments.

Put back your favorite wallpaper.

## POWER MANAGEMENT FEATURE

The power management feature of this product complies with power saving requirement of VESA DPMS. When activated, it automatically reduces unnecessary power consumption of the monitor when your computer is not in use.

To use the feature, the monitor needs to be connected to a VESA DPMS compliant computer. There is a power management step the monitor takes as described below. The power management function, including any timer settings is configured by the operating system. Check your operating system manual for information on how this can be configured.

### ■ Power Management Mode

When the H-sync signal / V-sync signal / H and V sync signals from the computer are off, the monitor enters into Power Management Mode which reduces the power consumption to less than 0.5W. The screen becomes dark, and the power indicator turns to orange. From Power Management Mode, the image reappears in several seconds when either the keyboard or the mouse are touched again.

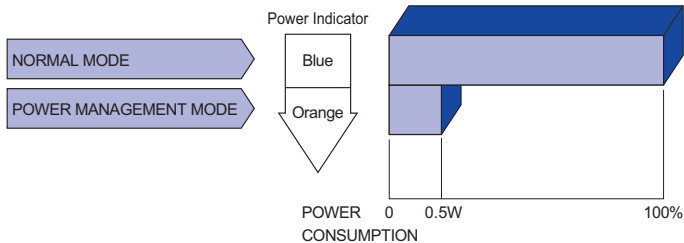

### NOTE

- Even when using the power management mode, the monitor consumes electricity. Turn off the Power Switch whenever the monitor is not in use, during the night and weekends, to avoid unnecessary power consumption.
- It is possible that the video signal from the computer may be on while the H or V sync signal is missing. In this instance, the POWER MANAGEMENT feature may not work properly.

## TROUBLE SHOOTING

If the monitor fails to operate correctly, please follow the steps below for a possible solution.

1. Perform the adjustments described in OPERATING THE MONITOR, depending on the problem you have. If the monitor does not get a picture, skip to 2.
2. Consult the following items if you cannot find an appropriate adjustment item in OPERATING THE MONITOR or if the problem persists.
3. If you are experiencing a problem which is not described below or you cannot correct the problem, discontinue using the monitor and contact your dealer or iiyama service center for further assistance.

| <b>Problem</b>                              | <b>Check</b>  |
|---|---|
| ① The picture does not appear.              |   |
| (Power indicator does not light up.)        | <input type="checkbox"/> The Power Cable is firmly seated in the socket.<br><input type="checkbox"/> The Power Switch is turned ON.<br><input type="checkbox"/> The AC socket is live. Please check with another piece of equipment.  |
| (Power indicator is blue.)                  | <input type="checkbox"/> If the blank screen saver is in active mode, touch the keyboard or the mouse.<br><input type="checkbox"/> Increase the Contrast and/or Brightness.<br><input type="checkbox"/> The computer is ON.<br><input type="checkbox"/> The Signal Cable is properly connected.<br><input type="checkbox"/> The signal timing of the computer is within the specification of the monitor. |
| (Power indicator is orange.)                | <input type="checkbox"/> If the monitor is in power management mode, touch the keyboard or the mouse.<br><input type="checkbox"/> The computer is ON.<br><input type="checkbox"/> The Signal Cable is properly connected.<br><input type="checkbox"/> The signal timing of the computer is within the specification of the monitor.   |
| ② The screen is not synchronized.           | <input type="checkbox"/> The Signal Cable is properly connected.<br><input type="checkbox"/> The signal timing of the computer is within the specification of the monitor.<br><input type="checkbox"/> The video output level of the computer is within the specification of the monitor.   |
| ③ The screen position is not in the center. | <input type="checkbox"/> The signal timing of the computer is within the specification of the monitor.  |
| ④ The screen is too bright or too dark.     | <input type="checkbox"/> The video output level of the computer is within the specification of the monitor.   |



| <b>Problem</b>                        | <b>Check</b>   |
|---------------------------------------|--|
| ⑤ The screen is shaking.              | <input type="checkbox"/> The power voltage is within the specification of the monitor.<br><input type="checkbox"/> The signal timing of the computer is within the specification of the monitor.   |
| ⑥ No sound.                           | <input type="checkbox"/> The audio equipment (computer etc.) is ON.<br><input type="checkbox"/> The Audio Cable is properly connected.<br><input type="checkbox"/> The Volume is turned up.<br><input type="checkbox"/> The Mute is OFF.<br><input type="checkbox"/> The audio output level of the audio equipment is within the specification of the monitor. |
| ⑦ The sound is too loud or too quiet. | <input type="checkbox"/> The audio output level of the audio equipment is within the specification of the monitor.   |
| ⑧ A strange noise is heard.           | <input type="checkbox"/> The Audio Cable is properly connected.  |

## RECYCLING INFORMATION

For better environment protection please don't dispose your monitor.  
 Please visit our web site: [www.iiyama.com/recycle](http://www.iiyama.com/recycle) for monitor recycling.

# APPENDIX

Design and specifications are subject to change without prior notice.

## SPECIFICATIONS

ENGLISH

|  |                  |   |
|--|------------------|---|
| Size Category                          |                  | 32"   |
| LCD Panel                              | Panel technology | VA  |
|  | Size             | Diagonal: 31.5" (80cm)  |
|  | Curvature        | 1800R   |
|  | Pixel pitch      | 0.364mm H × 0.364mm V   |
|  | Brightness       | 300cd/m <sup>2</sup> (Typical)  |
|  | Contrast ratio   | 3000 : 1 (Typical), Adv. Contrast Function Available  |
|  | Viewable angle   | Right / Left : 89 degrees each, Up / Down : 89 degrees each (Typical)   |
|  | Response time    | 3ms (Gray to Gray)  |
| Display Colors                         |                  | Approx. 16.7M   |
| Sync Frequency                         |                  | VGA: Horizontal: 30.0-82.0kHz, Vertical: 50-75Hz<br>DVI: Horizontal: 30.0-180.0kHz, Vertical: 50-144Hz<br>HDMI: Horizontal: 30.0-180.0kHz, Vertical: 24-144Hz<br>DisplayPort(without FreeSync) : Horizontal: 30.0-180.0kHz, Vertical: 50-144Hz          |
| FreeSync Range (1920 × 1080)           |                  | DisplayPort: Vertical: 48-144Hz   |
| Native Resolution                      |                  | 1920 × 1080, 2.1 MegaPixels   |
| Support max. resolution                |                  | VGA: 1920 × 1080 60Hz<br>DVI: 1920 × 1080 60Hz, 1920 × 1080 144Hz<br>HDMI: 1920 × 1080 60Hz, 1920 × 1080 144Hz<br>DisplayPort(without FreeSync): 1920 × 1080 60Hz, 1920 × 1080 144Hz<br>DisplayPort(with FreeSync): 1920 × 1080 60Hz, 1920 × 1080 144Hz |
| Input Connector                        |                  | VGA, DVI-D, HDMI, DisplayPort   |
| Plug & Play                            |                  | VESA DDC2B™   |
| Input Sync Signal                      |                  | Separate sync: TTL, Positive or Negative  |
| Input Video Signal                     |                  | Analog: 0.7Vp-p (Standard), 75Ω, Positive<br>Digital: DVI (Digital Visual Interface Standard Rev.1.0) compliance<br>Digital: HDMI, DisplayPort  |
| USB Standard                           |                  | Battery Charger   |
| Number of USB Ports<br>Connector shape |                  | Series A × 1  |
| Input Audio Connector                  |                  | ø 3.5mm mini jack (Stereo)  |
| Input Audio Signal                     |                  | 1.0Vrms maximum   |
| Headphone Connector                    |                  | ø 3.5mm mini jack (Stereo)  |
| Speakers                               |                  | 2W × 2 (Stereo speakers)  |
| Maximum Screen Size                    |                  | 698.40mm W × 392.85mm H / 27.5" W × 15.6" H   |
| Power Source                           |                  | 100-240VAC, 50/60Hz, 1.5A   |
| Power Consumption*                     |                  | 41W typical, Power management mode: 0.5W maximum<br>Energy Efficiency Class: B  |
| Dimensions / Net Weight                |                  | 721.0 × 545.5 × 254.0mm / 28.4 × 21.5 × 10.0" (W×H×D)<br>8.2kg / 18.0lbs  |

**NOTE** \* Audio equipments are not connected.

|                              |   |                             |
|------------------------------|---|-----------------------------|
| Tilt Angle                   | Upward: 12 degrees, Downward: 4 degrees |                             |
| Environmental Considerations | Operating: Temperature                  | 5 to 35°C / 41 to 95°F      |
|                              | Humidity                                | 10 to 80% (No condensation) |
|                              | Storage: Temperature                    | -20 to 60°C / -4 to 140°F   |
|                              | Humidity                                | 5 to 85% (No condensation)  |
| Approvals                    | CE, TÜV-Bauart, CU                      |                             |

**DIMENSIONS**

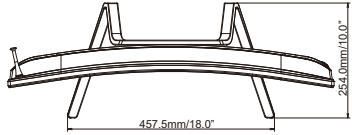
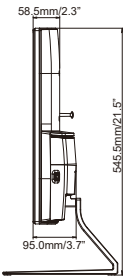
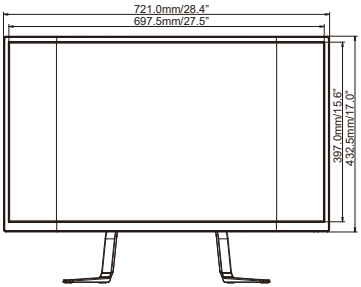

## COMPLIANT TIMING

| Video Mode |         |             | Horizontal Frequency | Vertical Frequency | Dot Clock  |
|------------|---------|-------------|----------------------|--------------------|------------|
| VESA       | VGA     | 640 × 480   | 31.469kHz            | 59.940Hz           | 25.175MHz  |
|            |         |             | 37.500kHz            | 75.000Hz           | 31.500MHz  |
|            | SVGA    | 800 × 600   | 37.879kHz            | 60.317Hz           | 40.000MHz  |
|            |         |             | 46.875kHz            | 75.000Hz           | 49.500MHz  |
|            | XGA     | 1024 × 768  | 48.363kHz            | 60.004Hz           | 65.000MHz  |
|            |         |             | 60.023kHz            | 75.029Hz           | 78.750MHz  |
|            | SXGA    | 1280 × 1024 | 63.981kHz            | 60.020Hz           | 108.000MHz |
|            |         |             | 79.976kHz            | 75.025Hz           | 135.000MHz |
|            | WSXGA+  | 1680 × 1050 | 65.290kHz            | 60.000Hz           | 146.250MHz |
|            | Full HD | 1920 × 1080 | 66.590kHz            | 59.930Hz           | 138.500MHz |
|            |         |             | 158.110kHz           | 144.000Hz          | 325.080MHz |

\*

**NOTE** \* DVI : Use the DVI-D dual-link signal cable.