

# **USER MANUAL**

# ***G-MASTER***

## **LCD Monitor**

ENGLISH

### ***G-MASTER GCB4580DQSN***

Thank you very much for choosing the iiyama LCD monitor.

We recommend that you take a few minutes to read carefully through this brief but comprehensive manual before installing and switching on the monitor. Please keep this manual in a safe place for your future reference.

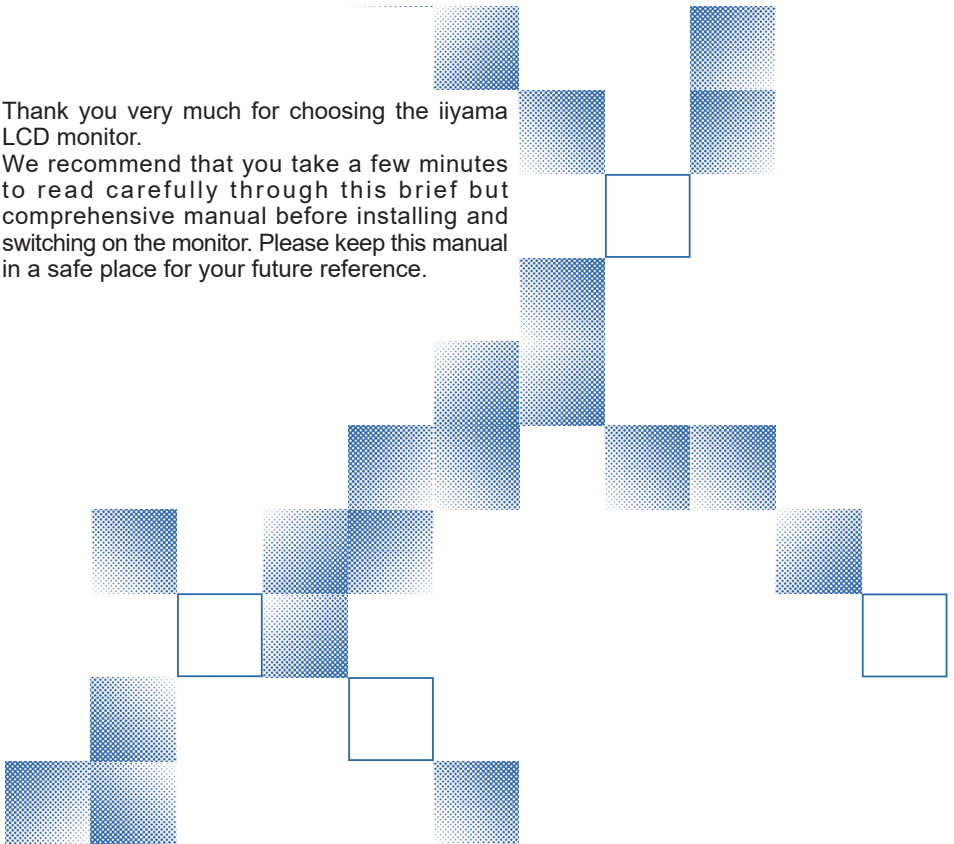



**Dear user, we congratulate you on the purchase of your iiyama LCD.**

For details on warranty and locally used pixel policies that apply directly after installation of your product please check the iiyama website.

**To report a fault, please contact your local support centre found at <https://iiyama.com>**

**Things to check before you call the iiyama information line**

- | if the power cable is connected securely and turned on?
- | if the display has been turned on?
- | if the signal cable is connected securely and the correct input selected?
- | if the computer has been restarted with the display connected?
- | if the graphics card is correctly installed with the latest drivers possible?
- | if the correct native resolution has been selected via 'Display Properties'?
- | If the R/G/B signal configuration is correct?
- | if the displays On Screen Menu is shown?
- | if the correct brightness and contrast settings have been set?
- | if given display tolerances and compatibility have been considered?
- | if via the On Screen Menu you have performed a Factory Reset/Recall?



**Before reporting the screen defect, please prepare the following information/evidence:**

- | model number \*
- | purchase receipt and serial number \*
- | name and address for collection
- | telephone/fax number, for availability during the day
- | convenient collection date (date, time)
- | short description of the defect

**Important Note:**

If there is no fault found in the collected equipment after inspection, the transferring party shall incur charges for transport and administration.

If you have checked all of the above and there is still no picture, call our information line for assistance in your country.

\* see the identification plate on the back of the case.

## CE MARKING DECLARATION OF CONFORMITY

This LCD monitor complies with the requirements of the EC/EU Directive 2014/30/EU "EMC Directive", 2014/35/EU "Low Voltage Directive", 2009/125/EC "ErP Directive" and 2011/65/EU "RoHS Directive".

The electro-magnetic susceptibility has been chosen at a level that gives correct operation in residential areas, business and light industrial premises and small-scale enterprises, inside as well as outside of the buildings. All places of operation are characterized by their connection to the public low voltage power supply system.

IYAMA CORPORATION: Wijkmeerstraat 8, 2131 HA Hoofddorp, The Netherlands

Model No. : PL4580DQ



We recommend recycling of used product. Please contact your dealer or iiyama service center. Recycle information is obtained via the Internet, using the address: <https://iiyama.com>

You can access the Web page of different countries from there.

- We reserve the right to change specifications without notice.
- All trademarks used in this user manual are the property of their respective owners.
- Eprel registration number GCB4580DQSN-B1 : 1774067

## TABLE OF CONTENTS

FOR YOUR SAFETY.....	1
SAFETY PRECAUTIONS.....	1
SPECIAL NOTES ON LCD MONITORS.....	3
CUSTOMER SERVICE.....	3
CLEANING.....	3
BEFORE YOU OPERATE THE MONITOR.....	4
FEATURES.....	4
CHECKING THE CONTENTS OF THE PACKAGE.....	4
USING ARM OR STAND.....	5
FITTING AND REMOVAL OF STAND.....	6
CONTROLS AND CONNECTORS.....	9
CONNECTING YOUR MONITOR.....	10
COMPUTER SETTING.....	12
ADJUSTING THE HEIGHT AND THE VIEWING ANGLE.....	12
OPERATING THE MONITOR.....	13
NAVIGATION BUTTON.....	13
ADJUSTMENT MENU CONTENTS.....	15
STANDBY FEATURE.....	27
TROUBLE SHOOTING.....	28
RECYCLING INFORMATION.....	29
APPENDIX.....	30
SPECIFICATIONS : G-MASTER GCB4580DQSN-B1.....	30
DIMENSIONS.....	31
COMPLIANT TIMING.....	32

# FOR YOUR SAFETY

## SAFETY PRECAUTIONS

### WARNING

#### **STOP OPERATING THE MONITOR IF YOU ARE AWARE OF ANY PROBLEMS**

If you notice any abnormal phenomena such as smoke, strange sounds or fumes, unplug the monitor and contact your dealer or iiyama service center immediately. Further use may be dangerous and can cause fire or electric shock.

#### **NEVER REMOVE THE CABINET**

High voltage circuits are inside the monitor. Removing the cabinet may expose you to the danger of fire or electric shock.

#### **DO NOT PUT ANY OBJECT INTO THE MONITOR**

Do not put any solid objects or liquids such as water into the monitor. In case of an accident, unplug your monitor immediately and contact your dealer or iiyama service center. Using the monitor with any object inside may cause fire, electric shock or damage.

#### **INSTALL THE MONITOR ON A FLAT, STABLE SURFACE**

The monitor may cause an injury if it falls or is dropped.

#### **DO NOT USE THE MONITOR NEAR WATER**

Do not use where water may be splashed or spilt onto the monitor as it may cause fire or electric shock.

#### **OPERATE UNDER THE SPECIFIED POWER SUPPLY**

Be sure to operate the monitor only with the specified power supply. Use of an incorrect voltage will cause malfunction and may cause fire or electric shock.

#### **PROTECT THE CABLES**

Do not pull or bend the power cable and signal cable. Do not place the monitor or any other heavy objects on the cables. If damaged, the cables may cause fire or electric shock.

#### **ADVERSE WEATHER CONDITIONS**

It is advisable not to operate the monitor during a heavy thunder storm as the continual breaks in power may cause malfunction. It is also advised not to touch the plug in these circumstances as it may cause electric shock.

### CAUTION

#### **INSTALLATION LOCATION**

Do not install the monitor where sudden temperature changes may occur, or in humid, dusty or smoky areas as it may cause fire, electric shock or damage. You should also avoid areas where the sun shines directly on the monitor.

## CAUTION

### DO NOT PLACE THE MONITOR IN A HAZARDOUS POSITION

The monitor may topple and cause injury if not suitably located. Please also ensure that you do not place any heavy objects on the monitor, and that all cables are routed such that children may not pull the cables and possibly cause injury.

### MAINTAIN GOOD VENTILATION

Ventilation slots are provided to keep the monitor from overheating. Covering the slots may cause fire. To allow adequate air circulation, place the monitor at least 10cm (or 4 inches) from any walls. When removing the tilt stand, the ventilation slots on the back side of the monitor can be blocked. This may overheat the monitor and may cause fire or damage. Make sure to allow enough ventilation when removing the tilt stand. Operating the monitor on its back, side, upside down or on a carpet or any other soft material may also cause damage.

### DISCONNECT THE CABLES WHEN YOU MOVE THE MONITOR

When you move the monitor, turn off the power switch, unplug the monitor and be sure the signal cable is disconnected. If you do not disconnect them, it may cause fire or electric shock.

### UNPLUG THE MONITOR

If the monitor is not in use for a long period of time it is recommended that it is left unplugged to avoid accidents.

### HOLD THE PLUG WHEN DISCONNECTING

To disconnect the power cable or signal cable, always pull it by the plug. Never pull on the cable itself as this may cause fire or electric shock.

### DO NOT TOUCH THE PLUG WITH WET HANDS

Pulling or inserting the plug with wet hands may cause electric shock.

### WHEN YOU INSTALL THE MONITOR ON YOUR COMPUTER

Be sure the computer is strong enough to hold the weight of the monitor, otherwise, you may damage your computer.

### CAREFUL! PROTECT YOUR HANDS AND FINGERS

- Be careful not to hurt your fingers or hands when you change the height or the angle.
- Injury can occur if care is not taken to avoid finger contact with the displays base when adjusting the height.

### REMARK FOR 24/7 USAGE

This product is not specifically designed for 24/7 usage in all environments.

### REMARK SPECIFIC TO DESKTOP USE

This product is designed for desktop use, not for digital signage (electronic signboard) applications such as ceiling hanging or wall mounting.as wall mounting.

## OTHERS

### ERGONOMIC RECOMMENDATIONS

To eliminate eye fatigue, do not operate the monitor against a bright background or in a dark room. For optimal viewing comfort, the monitor should be just below eye level and 40-60cm (16-24 inches) away from your eyes. When using the monitor over a prolonged time, a ten minute break every hour is recommended as looking at the screen continuously can cause eye strain.

## SPECIAL NOTES ON LCD MONITORS

The following symptoms are normal with LCD monitors and do not indicate a problem.

- NOTE**
- When you first turn on the LCD monitor, the picture may not fit in the display area because of the type of computer that is used. In this case, adjust the picture position to the correct position.
  - You may find slightly uneven brightness on the screen depending on the desktop pattern you use.
  - Due to the nature of the LCD screen, an afterimage of the previous screen may remain after switching the image, when the same image is displayed for hours. In this case, the screen can be recovered slowly by changing the image or turning off the Power Switch for some hours.

## CUSTOMER SERVICE

- NOTE**
- If you have to return your unit for service and the original packaging has been discarded, please contact your dealer or iiyama service center for advice or replacement packaging.

## CLEANING

- WARNING**
- If you drop any materials or liquids such as water into the monitor when cleaning, unplug the power cable immediately and contact your dealer or iiyama service center.

- CAUTION**
- For safety reasons, turn off the power switch and unplug the monitor before you clean it.

- NOTE**
- To protect the LCD panel, do not scratch or rub the screen with a hard object.
  - Never use any of the following strong solvents. These will damage the cabinet and the LCD screen.

Thinner	Spray-type cleaner
Benzine	Wax
Abrasive cleaner	Acid or Alkaline solvent

- Touching the cabinet with any product made from rubber or plastic for a long time may cause degeneration or loss of paint on the cabinet.

**CABINET** Stains can be removed with a cloth lightly moistened with a mild detergent solvent. Then wipe the cabinet with a soft dry cloth.

**LCD** Periodic cleaning with a soft dry cloth is recommended.

**SCREEN** Don't use tissue paper etc. because these will damage the LCD screen.

# BEFORE YOU OPERATE THE MONITOR

## FEATURES

- ◆ Supports Resolutions up to 5120 × 1440
- ◆ High Contrast 3000:1 (Typical), Advanced Contrast Function Available, Brightness 450cd/m<sup>2</sup> (Typical)
- ◆ Moving Picture Response Time 0.8ms
- ◆ Supports HDR400
- ◆ Flicker - Free
- ◆ Blue Light Reducer
- ◆ Digital Character Smoothing
- ◆ USB Type-C / RJ45 - Connectors
- ◆ USB Power Delivery supports up to 90W
- ◆ 2 × 3W Stereo Speakers
- ◆ Standby Feature
- ◆ VESA Mounting Standard (100×100 / 200×100mm) Compliant
- ◆ Keyhole for Security Lock

## CHECKING THE CONTENTS OF THE PACKAGE

The following accessories are included in your package. Check to see if they are enclosed with the monitor. If anything is missing or damaged, please contact your local iiyama dealer or regional iiyama office.

- |                           |                   |                     |
|---------------------------|-------------------|---------------------|
| ■ Power Cable*            | ■ HDMI Cable      | ■ DisplayPort Cable |
| ■ USB Cable (C-C)         | ■ USB Cable (A-B) | ■ Stand-Neck        |
| ■ Stand-Base with a screw | ■ Safety Guide    | ■ Quick Start Guide |

### CAUTION

\* All guarantees and warranties are void for any problems or damage caused by a power cable not supplied by iiyama.

An approved power cable greater or equal to H05VVF, 3G, 0.75mm<sup>2</sup> must be used.



## USING ARM OR STAND

### CAUTION

- This product is designed for desktop use, not for digital signage (electronic signboard) applications such as ceiling hanging or wall mounting.
- Before installation, make sure the display arm or desk arm stand is strong enough to hold the necessary weight of the monitor and the mount.
- Panel angle adjustment range : 20° upward and 3° downward
- This product cannot be used with the monitor screen facing downward/upward.

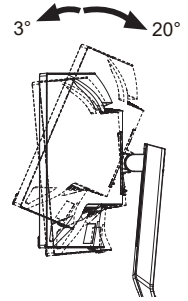

ENGLISH

## [ DISPLAY ARM OR DESK ARM STAND ]

### CAUTION

- When you use with the display arm or desk arm stand, in consideration of thickness of the mounting stage, tighten the M4 Screws (4pcs) which "L" length is 12mm to fasten the monitor. Using the screw longer than this may cause electric shock or damage because it may contact with the electrical parts inside the monitor.

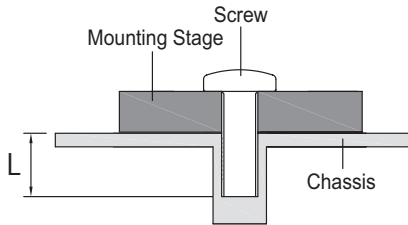

## [ LANDSCAPE MODE ]

This monitor can only be used in landscape. Do not rotate or operate the monitor in any other orientation than landscape.

### Available

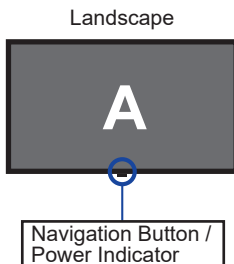

### Not Available



## FITTING AND REMOVAL OF STAND

- CAUTION**
- Put the monitor on a stable surface. The monitor may cause injury or damage if it falls or is dropped.
  - Do not give a strong impact to the monitor. It may cause damage.
  - Unplug the monitor before removal or installation to avoid an electric shock or a damage.

### <Installation>

- ① Place the carton box on a flat surface as shown below. Take out the Stand-Neck and Stand-Base from the upper protecting cushion inside the carton box.

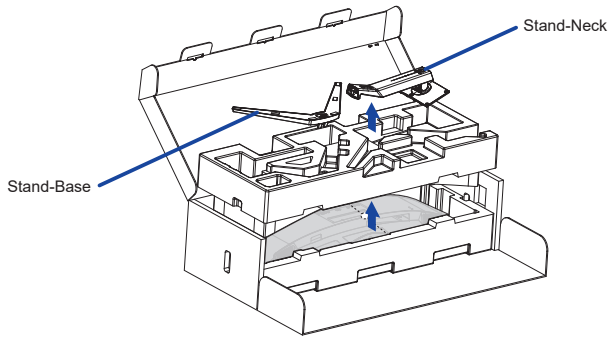

- ② Open the bag containing the monitor.

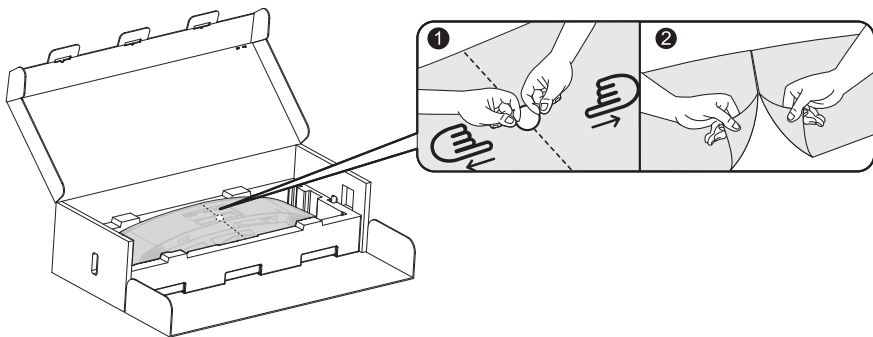

③ Install the Stand-Neck to the monitor in the lower protecting cushion.

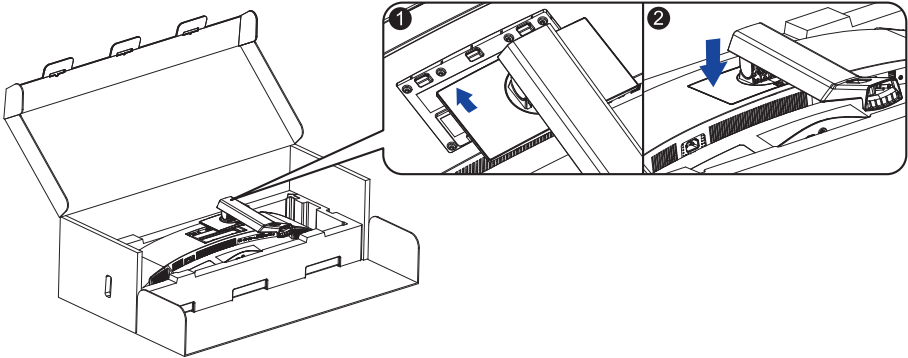

④ Install the Stand-Base to the Stand-Neck and then tighten the thumb screw to secure it.

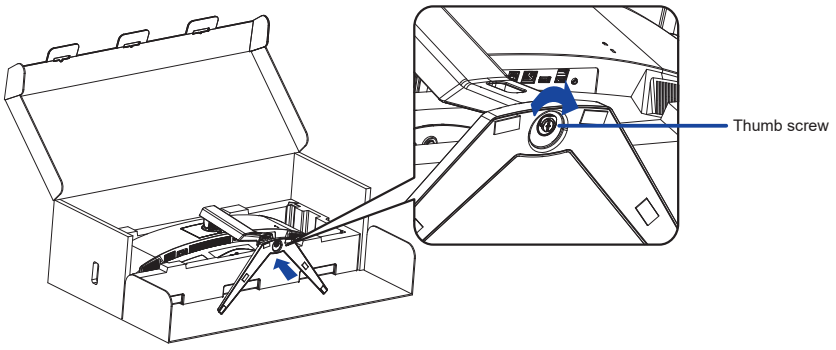

⑤ Carefully take out the assembled monitor from the protecting cushion and stand it up.

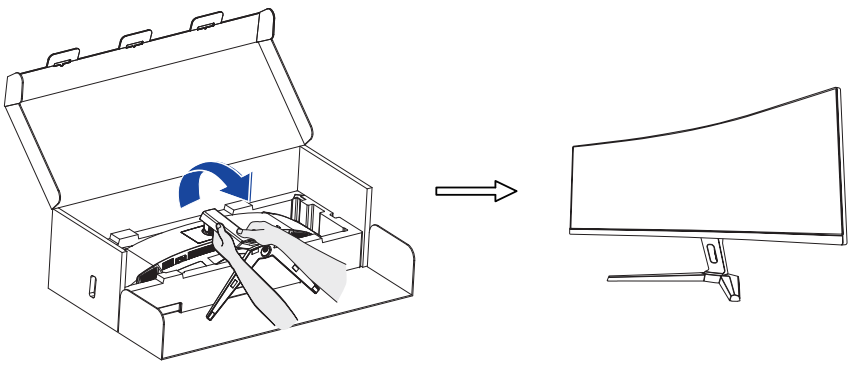

## <Removal>

- ① Put the monitor protecting cushion on a flat surface and place the monitor face down in it.
- ② Press the release button in the direction of the arrow as shown below to remove the stand.

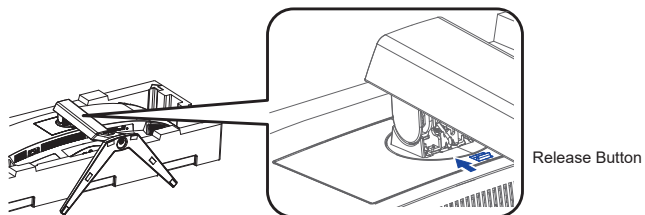



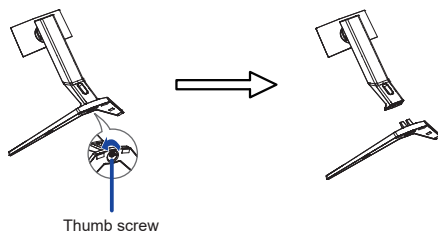

- ③ Loosen the thumb screw to disassemble the stand.

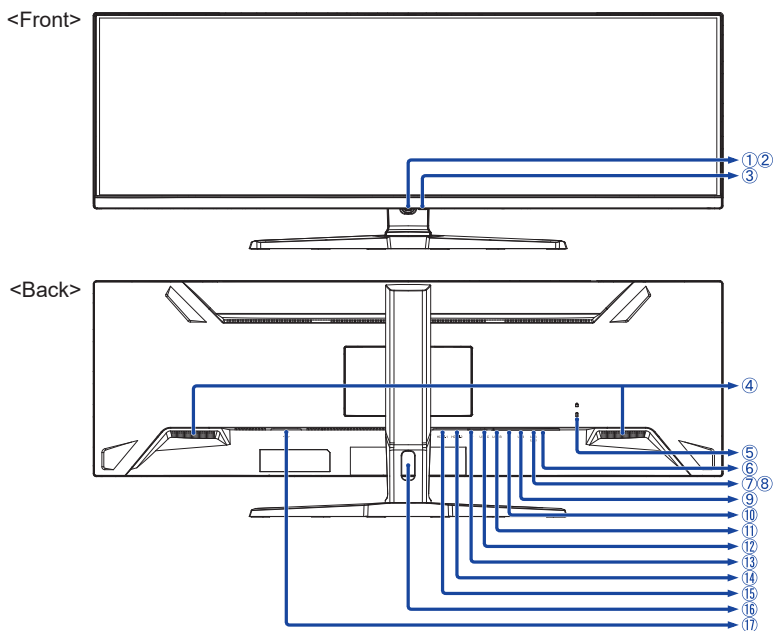

## CONTROLS AND CONNECTORS



- ① Navigation Button \*
- ② Power Indicator
  - NOTE** Blue: Normal operation
  - Orange: Standby mode
- ③ Power Button (  )
- ④ Speakers
- ⑤ Keyhole for Security Lock
  - NOTE** You can fasten a security lock and cable to prevent the monitor from being removed without your permission.
- ⑥ Headphone Connector (  )
- ⑦ USB Downstream Connector (USB) [USB3.2 Gen 1: 5Gbps, 5V, 900mA]
- ⑧ USB Downstream Connector (USB) [USB3.2 Gen 1: 5Gbps, 5V, 900mA]
- ⑨ USB Downstream Connector (USB) [USB3.2 Gen 1: 5Gbps, 5V, 900mA]
- ⑩ LAN(RJ45) Connector (  )
- ⑪ USB Upstream Connector (USB B)
- ⑫ USB Upstream Connector (USB C) [USB3.2 Gen 1: 5Gbps, 20V, 4.5A]
- ⑬ DisplayPort Connector (DP)
- ⑭ HDMI Connector (HDMI-2)
- ⑮ HDMI Connector (HDMI-1)
- ⑯ Cable Hole
- ⑰ AC Connector (  ) [Alternating current]

\* See NAVIGATION BUTTON on page 13.

## CONNECTING YOUR MONITOR

- ① Ensure that both the computer and the monitor are switched off.
- ② Connect the computer to the monitor with the signal cable.
- ③ Connect the computer to the monitor with the USB Cable (A-B).
- ④ Connect the computer to the monitor with the USB Cable (C-C) when viewing images on your monitor through the USB Type-C Connector or when using the monitor's USB hub function.\*
- ⑤ Connect the Power Cable to the monitor first and then to the power source.
- ⑥ Turn on your monitor and computer.

- \* ● When charging connected device via USB Type-C Connector, check if the device is equipped with a USB Type-C Connector that supports charging function via USB PD (=Power Delivery).
- Turn on the "USB BC" function to allow connected device to be charged even when the monitor is in standby mode. See page 24 for USB Battery Charge (USB BC) function.
- The USB power delivery is up to 90W. If the connected device required more than 90W for operation or for boot up (when the battery is drained), use the original power adapter that came with the device.
- If a separately purchased USB Type-C Cable is used, make sure the cable is certified by USB-IF and is full-featured with power delivery and video / audio / data transfer functions.
- If the monitor is in standby mode, it will not display a picture automatically in the following situations:
  1. First boot of the PC
  2. When the PC is resuming from standby modeTo display a picture, press the Navigation Button BACK. This behaviour is normal. To prevent this behaviour, please access the OSD menu and set "USB BC" to "ON".
- USB cable (A-C) is not included with the monitor. If you use a USB cable (A-C), please note that you can only transfer data.
- Compatibility with all connected devices is not guaranteed due to different user environments.

### NOTE

- Make sure that the building installation has a circuit breaker of 120/240V, 20A (maximum).
- The signal cables used for connecting the computer and monitor may vary with the type of computer used. An incorrect connection may cause serious damage to both the monitor and the computer. The cable supplied with the monitor is for a standard connector. If a special cable is required please contact your local iiyama dealer or regional iiyama office.
- The Class I pluggable equipment Type A must be connected to protective earth.
- The socket-outlet shall be installed near the equipment and shall be easily accessible.
- Excessive sound pressure from ear-/headphones can cause hearing damage/hearing loss.

## [ Example of Connection ]

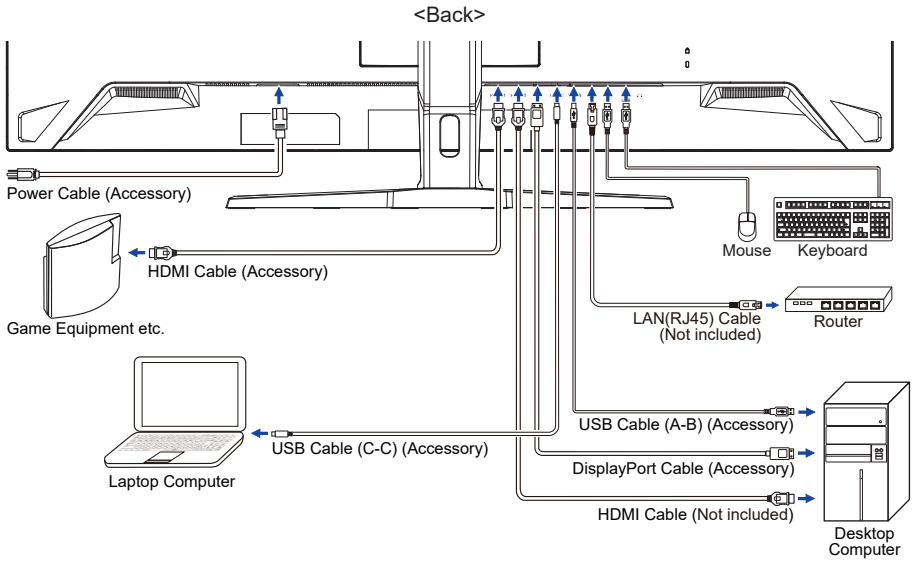

## [ Collect Cables ]

Put the cables through the Cable Hole to bundle them.

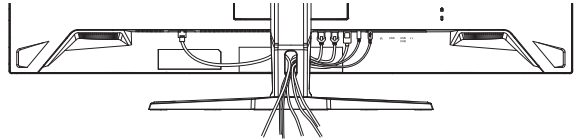

## COMPUTER SETTING

### ■ Signal Timing

Change to the desired signal timing listed on page 32: COMPLIANT TIMING.

## ADJUSTING THE HEIGHT AND THE VIEWING ANGLE

- For optimal viewing it is recommended to position yourself directly opposite to the full face of the monitor, then adjust the monitor's height and angle to your own preference.
- Hold the panel so that the monitor does not topple when you change the monitor's height or angle.
- You are able to adjust the monitor's height up to 130mm, the angle up to 20° upward and 3° downward.

### NOTE

- Do not touch the LCD screen when you change the height or the angle. It may cause damage or break the LCD screen.
- Careful attention is required not to pinch your fingers or hands into the moving part of the stand when you change the angle.
- Injury can occur if care is not taken to avoid finger contact with the displays base when adjusting the height.

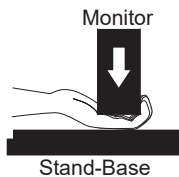
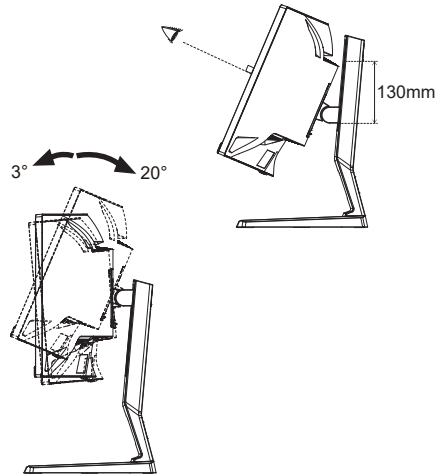



# OPERATING THE MONITOR

## NAVIGATION BUTTON

Press the following 5 places on the Navigation Button to move in each direction or make direct adjustments on the on-screen menu.

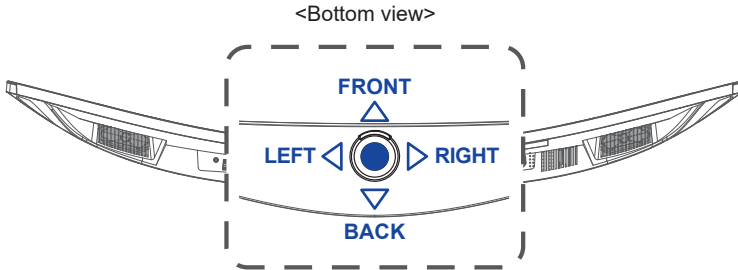

Navigation Button	On-screen menu	
● (CENTER)	Main menu / Execution	
FRONT	Down	<b>Direct</b> i-Style Mode
BACK	Up	<b>Direct</b> Input Select
RIGHT	Right	<b>Direct</b> Volume
LEFT	Left	<b>Direct</b> Night Mode

To create the best picture, your iiyama LCD monitor has been preset at the factory with the COMPLIANT TIMING shown on page 32. You are also able to adjust the picture by following the operation shown below.

- ① Press the Navigation Button **CENTER** to start the On-Screen Display (OSD) feature. There are additional Menu items which can be switched by pressing the Navigation Button **LEFT** / **RIGHT**.

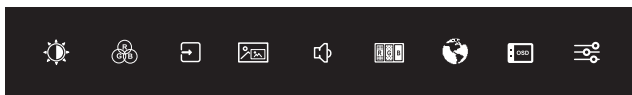

- ② Select the Menu item which contains the adjustment icon relating to the adjustment you want to make and press **CENTER**. Then, press the Navigation Button **FRONT** / **BACK** to highlight the desired adjustment icon.
- ③ Press **CENTER** again. Press **LEFT** / **RIGHT** to make the appropriate adjustment or setting.
- ④ Press **CENTER** and then press **LEFT** to leave the menu, so that the settings you just made would be automatically saved.



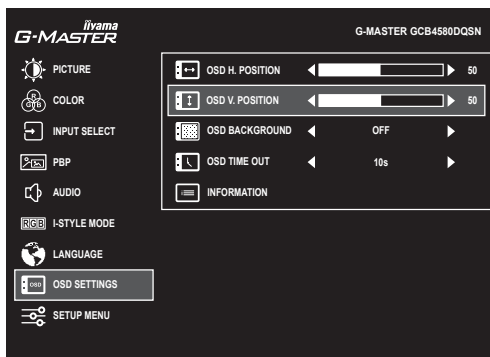













For example, to correct for OSD vertical position, select Menu item of "OSD Settings" and press **CENTER**. Then, select "OSD V. Position" by pressing **FRONT** / **BACK** and press **CENTER**. Press **LEFT** / **RIGHT** to change the OSD vertical position settings. The OSD vertical position should be changing accordingly while you are doing this.



Press **CENTER** and then press **LEFT** lastly to close the On-Screen Display feature. All changes are saved in the memory.

- NOTE**
- When button operations are aborted during adjustment, On-Screen Display disappears when the time set for the "OSD Time Out" has passed. Also, the Navigation Button **LEFT** can be used to return previous menu and turn off the On-Screen Display.
  - Any changes are automatically saved in the memory when the On-Screen Display disappears. Turning off the power should be avoided while using the Menu.

# ADJUSTMENT MENU CONTENTS

Adjustment Item	Problem / Option	Navigation Button
Brightness *1,2	Too dark	 
	Too bright	 
Contrast *3	Too dull	 
	Too intense	 
Black Tuner *2	From -5 to +5 You can adjust Dark shades.	 
Sharpness *4	You can change the picture quality from 0 to 100 (soft to sharp). Press  to change the picture quality in numerical order. Press  to change the picture quality in reverse numerical order. Adjust the picture quality at resolutions of 3840 × 1080 or less.	 
Overdrive *2	Off / 1 / 2 / 3 / 4 / 5 Improves the gray level response time of the LCD panel. A higher level results in a faster response time.	 
Adv. Contrast *2	On	Increases Contrast Ratio
	Off	Typical Contrast Ratio
Night Mode *2	Off	Normal
	1	Brightness of back-light is reduced.
	2	Brightness of back-light is reduced more than 1.
X-Res Technology *5	3	Brightness of back-light is reduced more than 2.
	Off	Normal
	Soft	Enhances the picture edge.
	Middle	Enhances the picture edge more than the Soft option.
	Hard	Enhances the picture edge more than the Middle option.

\*1 Adjust the Brightness when you are using the monitor in a dark room and feel the screen is too bright.  
 \*2 Selected adjustments and settings may not be possible due to other items that are enabled. See page 16 **Function Correlation Matrix 1** for more details.  
 \*3 Disabled only when i-Style Mode (Preset) is activated.  
 \*4 Disabled only when X-Res Technology is activated.  
 \*5 Disabled only when HDR is activated.

## Direct

You can skip the Menu items and directly display an option setting screen by using the following operations.

- Night Mode: Press the Navigation Button **LEFT**◀ when the Menu is not displayed.

### ■ Function Correlation Matrix 1

Selected item		Picture				
		Brightness	Black Tuner	Overdrive	Adv. Contrast	Night Mode
Picture	Adv. Contrast	–	✓	✓	/	–
	Night Mode	–	✓	✓		–
Color	Blue Light Reducer	–	✓	✓	–	–
PBP	PBP Mode	✓	✓	–	–	✓
i-Style Mode	Preset	–	–	–	–	–
Setup Menu	MST	✓	✓	–	–	✓
	MBR	–	–	✓	–	–
	HDR	–	–	–	–	–

✓ : Available

– : Not available



## Color \*1,2

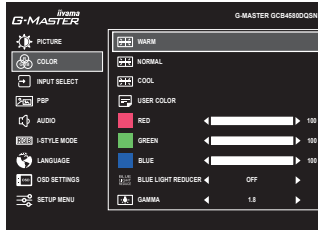

Adjustment Item	Problem / Option	Navigation Button
Warm *3	Warm color	
Normal *3	Normal color	
Cool *3	Cool color	
User Color *3	Red	Too weak
	Green	Too strong
	Blue	
Blue Light Reducer *4,5	Off	Typical
	1	Blue light is reduced.
	2	Blue light is reduced more than 1.
	3	Blue light is reduced more than 2.
Gamma *5	1.8	You can set the Gamma.
	2.2	
	2.6	

\*1 Disabled when i-Style Mode (Preset) is activated.

\*2 Disabled when HDR is activated.

\*3 Disabled when Blue Light Reducer is activated.

\*4 Disabled when Adv. Contrast, Night Mode or i-Style Mode (User Mode) is activated.

\*5 Disabled when MBR is activated.

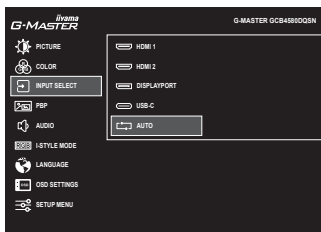

## Input Select

**Direct**

### Adjustment Item

### Option

Input Select

HDMI 1	Selects the HDMI 1 input.
HDMI 2	Selects the HDMI 2 input.
DISPLAYPORT	Selects the DisplayPort input.
USB-C	Selects the USB Type-C input.
AUTO *	Searches for an available input source and select automatically.

**NOTE** "AUTO" function enables automatic selection of the input sources available. The input source from the computer in standby mode can not be selected. If you manually select one of the input sources, the other source is not automatically selected.

\* Disabled when MST is activated.

## Direct

You can skip the Menu items and directly display an option setting screen by using the following operations.

- Input Select: Press the Navigation Button **BACK** when the Menu is not displayed.





PBP \*1



Adjustment Item	Option	
PBP Mode *2	Off	PBP Mode is turned off.
	On	Displays the main image on the left and the sub image on the right.
Sub Win Input *3	HDMI1	Selects the HDMI1 input for the sub screen.
	HDMI2	Selects the HDMI2 input for the sub screen.
	DisplayPort	Selects the DisplayPort input for the sub screen.
	USB-C	Selects the USB Type-C input for the sub screen.
PBP Swap *3	Swaps the Main/Sub screens when PBP Mode is active.	
Audio Input *3	MAIN WIN	Selects the main screen audio input.
	SUB WIN	Selects the sub screen audio input.

\*1 PBP = Picture by Picture





Disabled when DSC or HDR is activated.

\*2 With this function, display images from two sources side by side.

\*3 Available only when PBP Mode is activated.

 Audio



Adjustment Item	Problem / Option		Navigation Button
Volume <span style="float: right;"><b>Direct</b></span>	Too soft Too loud		   
Mute	On	Turns off the sound temporarily.	
	Off	Returns the sound volume to the previous level.	

**Direct**

You can skip the Menu items and directly display an adjustment scale by using the following operations.

- Volume: Press the Navigation Button **RIGHT▶** when the Menu is not displayed.





## i-Style Mode

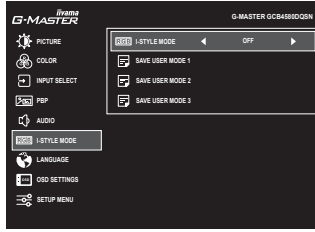

Adjustment Item	Option	
i-Style Mode * <b>Direct</b>	Off	i-Style Mode is tuned off.
	Standard	For general windows environment and monitor default setting
	Sport	For sports game environment
	FPS	For FPS game environment
	Strategy	For Strategy game environment
	Text	For text editing and viewing in a word processing environment
	User Mode 1	Applies customized monitor settings.
	User Mode 2	Applies customized monitor settings.
	User Mode 3	Applies customized monitor settings.
Save User Mode 1 / 2 / 3	Saves the settings of the screen adjustment.	

**NOTE** The monitor memorizes your customized settings below. Those settings can be invoked from "i-Style Mode" later.  
 Brightness, Contrast, Black Tuner, Sharpness, Overdrive, Adv. Contrast, Night Mode, X-Res Technology, Warm/Normal/Cool, User Color, Gamma, Volume, Mute, Video Mode Adjust

\* Disabled when Blue Light Reducer or HDR is activated.

### Direct

You can skip the Menu items and directly display an option setting screen by using the following operations.

- i-Style Mode: Press the Navigation Button **FRONT** when the Menu is not displayed.



# Language

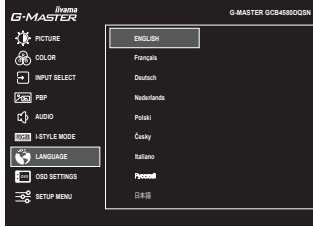

## Adjustment Item

## Option

Language









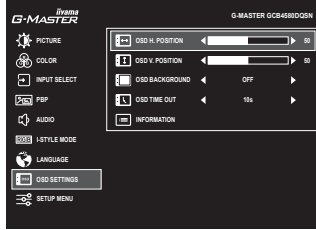





English	English	Česky	Czech
Français	French	Italiano	Italian
Deutsch	German	Русский	Russian
Nederlands	Dutch	日本語	Japanese
Polski	Polish		

ENGLISH



## OSD Settings



Adjustment Item	Problem / Option	Navigation Button
OSD H. Position	OSD is too left OSD is too right	   
OSD V. Position	OSD is too low OSD is too high	   
OSD Background	The background of OSD is made transparent. Off / 1 / 2 / 3 / 4	  
OSD Time Out	You can set the OSD display duration time. 5 / 10 / 30 / 60 seconds	  
Information	Displays the information regarding the current input signal coming from the graphic card in your computer. <Example> 	<b>NOTE</b> See your graphic card user guide for more information about changing the resolution and refresh rate.

## Setup Menu

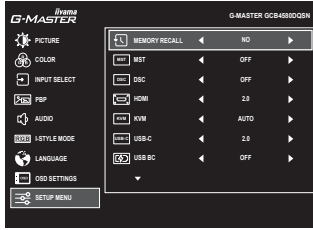

Adjustment Item	Option	
Memory Recall	Yes	Factory-preset data is restored.
	No	Returns to Menu.
MST *1,2,5	On	Enables PBP functionality with connecting to either DisplayPort or USB Type-C input.
	Off	Disables MST function.
DSC *1,2,5	On	Enables 8-bit color display with a resolution of 5120 × 1440 at 165Hz.
	Off	Disables DSC function.
HDMI *4	2.0	Selects the version of HDMI.
	2.1	
KVM	Auto	When two or three computers are connected to the monitor, you can link the input source with the USB upstream connector.
	USB B	
	USB C	
USB-C	2.0	Selects the data transfer speed when connecting via USB Type-C.
	3.0	
<p><b>NOTE</b> When 3.0 is selected on USB Type-C input, the resolutions up to 3840 × 1080 at 85Hz can be supported.</p>		
USB BC	On	USB devices can be charged even when the monitor is in the standby mode.
	Off	USB devices can not be charged when the monitor is in the standby mode.
<p><b>NOTE</b> When the monitor is turned off, USB devices cannot be charged even when the USB BC function is on. While this function is off, USB devices do not operate even when the monitor is in standby mode to save standby electricity. When operating USB devices, turn this function on.</p>		

\*1 Available for DisplayPort or USB Type-C input only.

\*2 On/Off of the MST function is not dependent on input signal switching.

\*3 DSC = Display Stream Compression



\*4 Switching to Version 2.1 allows you to receive signals up to 5120 × 1440 at 165Hz.

\*5 Selected adjustments and settings may not be possible due to other items that are enabled. See page 26 **Function Correlation Matrix 2** for more details.

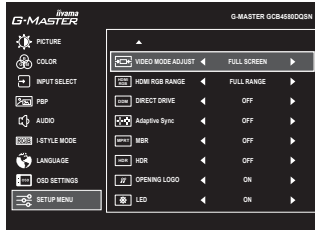

## Setup Menu



Adjustment Item	Option	Navigation Button
Video Mode Adjust *5,6	Full Screen	Full screen display
	Aspect Ratio	Expansion display of Aspect
	Dot By Dot	Displays the picture dot by dot.
	17 inch	Displays the picture as 17 inch screen (5 : 4)
	19 inch	Displays the picture as 19 inch screen (5 : 4)
	19.5 inch	Displays the picture as 19.5 inch screen (16 : 9)
	21.5 inch	Displays the picture as 21.5 inch screen (16 : 9)
	23 inch	Displays the picture as 23 inch screen (16 : 9)
HDMI RGB Range *7	Full Range	For full-range color scale signal
	Limited Range	For limited color scale signal
Direct Drive *5	On	Reduces the input-lag.
	Off	Typical
<b>NOTE</b> Changing Resolution and Refresh rate or turning Power Off/On might disable the Direct Drive function.		
Adaptive Sync *5	On	Enables the Adaptive Sync function.
	Off	The Adaptive Sync function is turned off.
MBR *5	Off / 1 / 2 / 3 / 4 / 5 / 6 / 7	Reduces motion blur on the LCD panel. Available only when   
HDR *5	On	For HDR (High Dynamic Range) signal
	Off	For normal signal
Opening Logo	On	G-MASTER Logo is displayed when the monitor is turned on.
	Off	G-MASTER Logo is not displayed when the monitor is turned on.
LED	On	The Power Indicator is turned On.
	Off	The Power Indicator is turned Off.
<b>NOTE</b> Turn Off the Power Indicator when you are bothered by the light.		

\*6 Selectable only at resolutions 3840 × 2160 or less.

\*7 Available for HDMI input only.

## ■ Function Correlation Matrix 2

Selected item / Active item		Setup Menu						
		MST	DSC	Video Mode Adjust	Direct Drive	Adaptive Sync	MBR	HDR
Picture	Adv. Contrast	✓	✓	✓	✓	✓	-	✓
	Night Mode	✓	✓	✓	✓	✓	-	✓
	X-Res Technology	✓	✓	✓	✓	✓	-	✓
PBP	PBP Mode	-	-	-	-	-	-	-
Setup Menu	MST	✓	-	-	-	-	-	-
	DSC	-	✓	✓	-	✓	✓	✓
	Direct Drive	-	-	-	✓	-	✓	-
	Adaptive Sync	-	✓	-	-	✓	-	✓
	MBR	✓	✓	-	✓	✓	✓	-
	HDR	-	✓	✓	-	✓	-	✓

✓ : Available

- : Not available

### ● Lock Mode

#### <OSD Menu>

1. The OSD lock will be activated by pressing the Navigation Button **RIGHT** for 5 seconds. If you try to access the OSD by pressing the Navigation Button, message "OSD LOCKED" will appear on the screen.
2. The OSD lock will be deactivated by pressing the Navigation Button **RIGHT** again for 5 seconds.

#### <Power Button>

1. The Power Button lock will be activated by pressing the Navigation Button **LEFT** for 5 seconds. Locking the Power Button means that won't be able to turn off the Monitor while the Power Button is locked. If you press the Power Button, message "POWER BUTTON LOCKED" will appear on the screen.
2. The Power Button lock will be deactivated by pressing the Navigation Button **LEFT** again for 5 seconds.

## STANDBY FEATURE

This product features the standby function. When activated, it automatically reduces unnecessary power consumption of the monitor when your computer is not in use.

There is a standby step the monitor takes as described below. The standby function, including any timer settings is configured by the operating system. Check your operating system manual for information on how this can be configured.

### ■ Standby Mode

When the video signal from the computer is off, the monitor enters into Standby Mode which reduces the power consumption to 0.5W or less\*. The screen becomes dark, and the power indicator turns to orange. From Standby Mode, the image reappears in several seconds when either the keyboard or the mouse are touched again.

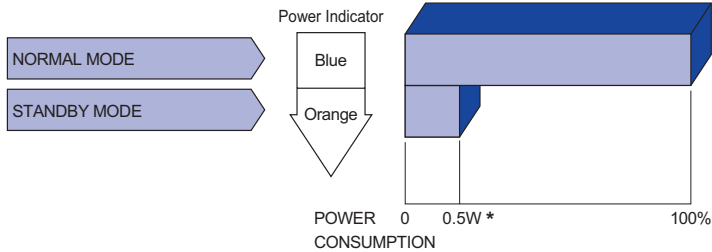

\* When the USB devices are not connected.

# TROUBLE SHOOTING

If the monitor fails to operate correctly, please follow the steps below for a possible solution.

1. Perform the adjustments described in OPERATING THE MONITOR, depending on the problem you have. If the monitor does not get a picture, skip to 2.
2. Consult the following items if you cannot find an appropriate adjustment item in OPERATING THE MONITOR or if the problem persists.
3. If you are experiencing a problem which is not described below or you cannot correct the problem, discontinue using the monitor and contact your dealer or iiyama service center for further assistance.

## Problem

## Check

- ① The picture does not appear.

(Power indicator does not light up.)

- The Power Cable is firmly seated in the socket.
- The Power Button is turned ON.
- The AC socket is live. Please check with another piece of equipment.

(Power indicator is blue.)

- If the blank screen saver is in active mode, touch the keyboard or the mouse.
- Increase the Contrast and/or Brightness.
- The computer is ON.
- The Signal Cable is properly connected.
- The signal timing of the computer is within the specification of the monitor.

(Power indicator is orange.)

- If the monitor is in standby mode, touch the keyboard or the mouse.
- The computer is ON.
- The Signal Cable is properly connected.
- The signal timing of the computer is within the specification of the monitor.

- ② The screen is not synchronized.

- The Signal Cable is properly connected.
- The signal timing of the computer is within the specification of the monitor.

- ③ The screen position is not in the center.

- The signal timing of the computer is within the specification of the monitor.

- ④ The screen is too bright or too dark.

- The video output level of the computer is within the specification of the monitor.

- ⑤ The screen is shaking.

- The power voltage is within the specification of the monitor.
- The signal timing of the computer is within the specification of the monitor.

- ⑥ No sound.

- The audio equipment (computer etc.) is ON.
- The Volume is turned up.
- The Mute is OFF.
- The audio output level of the audio equipment is within the specification of the monitor.

- ⑦ The sound is too loud or too quiet.

- The audio output level of the audio equipment is within the specification of the monitor.



# RECYCLING INFORMATION

For better environment protection please don't dispose your monitor.  
Please visit our web site: <https://iiyama.com> for monitor recycling.

# APPENDIX

Design and specifications are subject to change without prior notice.

## SPECIFICATIONS : G-MASTER GCB4580DQSN-B1

ENGLISH

Size Category	45"	
LCD Panel	Panel technology	VA
	Size	Diagonal: 44.5" (113cm)
	Curvature	1500R
	Pixel pitch	0.212mm H × 0.212mm V
	Brightness	450cd/m <sup>2</sup> (Typical), 150cd/m <sup>2</sup> (Default / Energy Saving)
	Contrast ratio	3000 : 1 (Typical), Advanced Contrast Function Available
	Viewable angle	Right / Left: 89° each, Up / Down: 89° each (Typical)
	MPRT	0.8ms
Display Colors	Approx. 16.7 Million	
Sync Frequency	HDMI: Horizontal: 30.0-260.0kHz, Vertical: 48-165Hz DisplayPort: Horizontal: 30.0-260.0kHz, Vertical: 48-165Hz USB Type-C: Horizontal: 30.0-260.0kHz, Vertical: 48-165Hz	
Native Resolution	5120 × 1440, 7.4 MegaPixels	
Supported max. resolution	5120 × 1440, 165Hz	
Input Connector	HDMI × 2, DisplayPort, USB Type-B, USB Type-C (Alt Mode)	
Input Video Signal	HDMI, DisplayPort, USB Type-C (Alt Mode)	
USB Standard	USB3.2 Gen 1 (5Gbps, DC5V, 900mA), USB Power Delivery (90W)	
Number of USB Ports	2 Upstream: Type-B, Type-C	
Connector shape	3 Downstream: Type-A	
LAN Port	RJ45	
Headphone Connector	ø 3.5mm mini jack (Stereo)	
Speakers	3W × 2 (Stereo speakers)	
Maximum Screen Size	1087.5mm W × 305.9mm H / 42.8" W × 12.0" H	
Power Source	100-240VAC, 50/60Hz, 2.5A	
Power Consumption *	60W typical, 37W (Default / Energy Saving) Standby mode: 0.5W maximum, Off mode: 0.3W maximum	
Dimensions	1090.0 × 409.0 - 539.0 × 275.0mm / 42.9 × 16.1 - 21.2 × 10.8" (W×H×D)	
Net Weight	11.2kg / 24.7lbs	
Height Adjustment Range	130mm	
Tilt Angle	Upward: 20°, Downward: 3°	
Environmental Considerations	Operating: Temperature	5 to 35°C / 41 to 95°F
	Humidity	10 to 80% (No condensation)
Storage:	Temperature	-20 to 60°C / -4 to 140°F
	Humidity	10 to 90% (No condensation)
Approvals	CE, UKCA, TÜV-Bauart, VCCI, PSE	

**NOTE** \* When the USB devices are not connected.

# DIMENSIONS

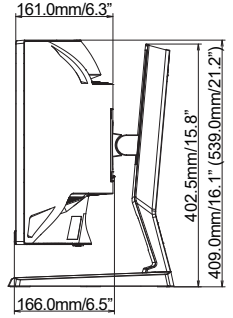
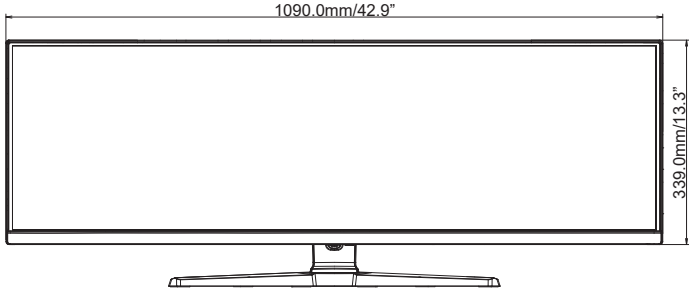
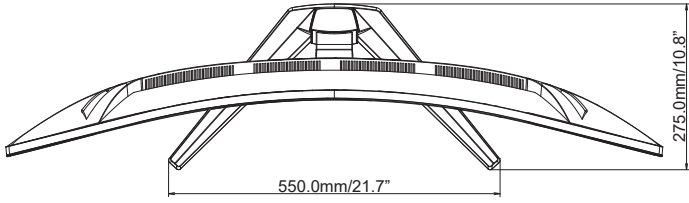

( ) : Maximum adjustment range

## COMPLIANT TIMING

Video Mode	Horizontal Frequency	Vertical Frequency	Dot Clock	HDMI			DISPLAYPORT / USB-C				USB-C
				2.0 Default	2.1	PBP On	DSC Off Default	DSC On	PBP On	MST On	3.0
800 × 600	37.879kHz	60.317Hz	40.000MHz	✓	✓	✓	✓	✓	✓	✓	✓
	46.875kHz	75.000Hz	49.500MHz	✓	✓	✓	✓	✓	✓	✓	✓
1024 × 768	48.363kHz	60.004Hz	65.000MHz	✓	✓	✓	✓	✓	✓	✓	✓
	60.023kHz	75.029Hz	78.750MHz	✓	✓	✓	✓	✓	✓	✓	✓
1280 × 1024	63.981kHz	60.020Hz	108.000MHz	✓	✓	✓	✓	✓	✓	✓	✓
	79.976kHz	75.025Hz	135.000MHz	✓	✓	✓	✓	✓	✓	✓	✓
1920 × 1080	67.500kHz	60.000Hz	148.500MHz	✓	✓	✓	✓	✓	✓	✓	✓
	135.000kHz	120.000Hz	297.000MHz	✓	✓	✓	✓	✓	✓	✓	✓
2560 × 1440	88.787kHz	59.951Hz	241.500MHz			✓			✓	✓	✓
	111.070kHz	75.000Hz	302.124MHz			✓			✓	✓	
	151.000kHz	100.000Hz	410.720MHz			✓			✓	✓	
	183.000kHz	120.000Hz	497.760MHz	✓	✓	✓	✓	✓	✓	✓	
	222.190kHz	144.000Hz	592.364MHz			✓			✓	✓	
3840 × 1080	242.550kHz	165.000Hz	646.638MHz				✓	✓	✓		
	66.660kHz	60.000Hz	266.640MHz	✓	✓		✓	✓			✓
	83.320kHz	75.000Hz	333.300MHz								✓
	94.780kHz	85.000Hz	380.996MHz								✓
3840 × 2160	133.800kHz	120.000Hz	537.876MHz	✓			✓				
	135.000kHz	60.000Hz	594.000MHz	✓	✓						
	270.000kHz	120.000Hz	1188.000MHz		✓*1						
5120 × 1440	88.860kHz	60.000Hz	469.181MHz		✓*1		✓	✓			
	111.070kHz	75.000Hz	586.476MHz		✓*1		✓	✓			
	125.890kHz	85.000Hz	664.673MHz		✓*1		✓	✓			
	177.720kHz	120.000Hz	938.362MHz		✓*1		✓	✓			
	246.180kHz	165.000Hz	1299.830MHz		✓*1			✓*2			

**NOTE** \*1 The output of the graphic card must support HDMI version 2.1, and it needs to be selected in the Menu "HDMI".

\*2 The output of the graphic card must support the DSC technology, and the "DSC" function in the Menu must be enabled.

Console	1080p (1920×1080)	1440p (2560×1440)	2160p (3840×2160)
PS5	60Hz / 120Hz	60Hz / 120Hz	60Hz / 120Hz *1
Xbox Series X/S	60Hz / 120Hz	60Hz / 120Hz	60Hz *2 / 120Hz *1,2

\*1 Version 2.1 must be selected in the Menu "HDMI".

\*2 Available for Xbox Series X only.