

USER MANUAL

ProLite

LCD Monitor

ENGLISH

ProLite TE9813A
ProLite TE8613A
ProLite TE7513A
ProLite TE6513A
ProLite TE5513A

Thank you very much for choosing the iiyama LCD monitor.

We recommend that you take a few minutes to read this comprehensive manual carefully before installing and switching on the monitor. Please keep this manual in a safe place for your future reference.



Dear user, we congratulate you on the purchase of your iiyama LCD.

For details on warranty and locally used pixel policies that apply directly after installation of your product please check the iiyama website.

To report a fault, please contact your local support centre found at <https://iiyama.com>

Things to check before you call the iiyama information line

- | if the power cable is connected securely and turned on?
- | if the display has been turned on?
- | if the signal cable is connected securely and the correct input selected?
- | if the computer has been restarted with the display connected?
- | if the graphics card is correctly installed with the latest drivers possible?
- | if the correct native resolution has been selected via 'Display Properties'?
- | If the R/G/B signal configuration is correct?
- | if the displays On Screen Menu is shown?
- | if the correct brightness and contrast settings have been set?
- | if given display tolerances and compatibility have been considered?
- | if via the On Screen Menu you have performed a Factory Reset/Recall?

Before reporting the screen defect, please prepare the following information/evidence:

- | model number *
- | purchase receipt and serial number *
- | name and address for collection
- | telephone/fax number, for availability during the day
- | convenient collection date (date, time)
- | short description of the defect

Important Note:

If there is no fault found in the collected equipment after inspection, the transferring party shall incur charges for transport and administration.

If you have checked all of the above and there is still no picture, call our information line for assistance in your country.

Feedback on health and safety issues

If you have any health and safety concerns or questions about the product (including when using the product), please contact iiyama support through our website. You can also contact us by calling +31 204460404. After receiving your feedback, we will ask the responsible unit to handle it as soon as possible and a dedicated person will get back to you. Your feedback will also be recorded and incorporated into our evaluation for improvements

* see the identification plate on the back of the case.

CE MARKING DECLARATION OF CONFORMITY

This LCD monitor complies with the requirements of the EC/EU Directive 2014/30/EU "EMC Directive", 2014/35/EU "Low Voltage Directive", 2009/125/EC "ErP Directive" and 2011/65/EU "RoHS Directive".

Warning

This equipment is compliant with Class A of EN55032. In a residential environment this equipment may cause radio interference.

Operating Frequency range and the maximum output power (EIRP) are listed below:

PL9813 / PL8613 / PL7513 / PL6513 / PL5513

Function	Frequency	Maximum Output Power (EIRP)
WiFi	2412-2472 MHz	15.70 dBm
	5180-5240 MHz	16.41 dBm
	5260-5320 MHz	16.54 dBm
	5500-5700 MHz	16.26 dBm
	5745-5825 MHz	11.09 dBm
Bluetooth BLE	2402~2480 MHz	6.51 dBm
Bluetooth BR+EDR	2402~2480 MHz	5.97 dBm

IYYAMA CORPORATION: Wijkmeesterstraat 8, 2131 HA Hoofddorp, The Netherlands

Model No. : PL9813 / PL8613 / PL7513 / PL6513 / PL5513

WARNING

THIS PRODUCT CONTAINS TWO AAA CARBON ZINC DRY BATTERIES



Do not heat batteries.

Do not deform battery.

Do not recharge battery.

Do not dispose of battery in fire.

Keep battery away from direct sunlight and heat sources, do not storage in high temperature and humidity environment.

Do not ingest battery, Chemical Burn Hazard.

Keep new and used batteries away from children.

If the battery compartment does not close securely, stop using the product and keep it away from children

If you think batteries might have been swallowed or placed inside any part of the body, seek immediate medical attention.

Battery Model	R03
Battery Voltage/Typical Capacity	1.5 V, 400 mAh
Battery Manufacturer	DongGuan Tianqiu Enterprise Co., Ltd. TianQiu Industrial Park, Xinji Industrial Zone, Machong Town, Dongguan FuangDong, P.R. China
Battery Authorised Representative	Apex CE Specialists GmbH Grafenberger Allee 277, 40237 Düsseldorf, DE



We recommend recycling of used product. Please contact your dealer or iiyama service center. Recycle information is obtained via the Internet, using the address: <https://iiyama.com>

You can access the Web page of different countries from there.

④ We reserve the right to change specifications without notice.

④ All trademarks used in this user manual are the property of their respective owners.

④ Eprel registration number TE9813A-B1AG: 2239807, TE8613A-B1AG: 2239823, TE7513A-B1AG: 2239841

TE6513A-B1AG: 2239867, TE5513A-B1AG: 2239905

TABLE OF CONTENTS

FOR YOUR SAFETY	1	
SAFETY PRECAUTIONS	1	
SPECIAL NOTES ON LCD MONITORS	3	
CUSTOMER SERVICE	4	
CLEANING	5	
BEFORE YOU OPERATE THE MONITOR	6	
FEATURES	6	
CHECKING THE CONTENTS OF THE PACKAGE	6	
UNPACKING	7	
SPECIAL NOTES ON THE TOUCH PANEL	7	
INSTALLATION	8	
CONTROLS AND CONNECTORS : MONITOR	10	
FUNCTIONS OF THE REMOTE CONTROL	12	
PREPARING THE REMOTE CONTROL	13	
BASIC OPERATION	15	
CONNECTING YOUR MONITOR	18	
COMPUTER SETTING	21	
OPERATING THE MONITOR	22	
SOURCE OF SIGNAL	24	
DEVICE MENU	25	
STANDBY FEATURE	48	
TROUBLE SHOOTING	49	
RECYCLING INFORMATION	50	
APPENDIX	51	
SPECIFICATIONS : ProLite TE9813A-B1AG	51	
SPECIFICATIONS : ProLite TE8613A-B1AG	53	
SPECIFICATIONS : ProLite TE7513A-B1AG	55	
SPECIFICATIONS : ProLite TE6513A-B1AG	57	
SPECIFICATIONS : ProLite TE5513A-B1AG	59	
DIMENSIONS : ProLite TE9813A	61	
DIMENSIONS : ProLite TE8613A	61	
DIMENSIONS : ProLite TE7513A	62	
DIMENSIONS : ProLite TE6513A	62	
DIMENSIONS : ProLite TE5513A	63	
COMPLIANT TIMING	64	

FOR YOUR SAFETY

SAFETY PRECAUTIONS

WARNING

STOP OPERATING THE MONITOR WHEN YOU SENSE TROUBLE

If you notice any abnormal phenomena such as smoke, strange sounds or fumes, unplug the monitor and contact your dealer or iiyama service center immediately. Further use may be dangerous and can cause fire or electric shock.

NEVER REMOVE THE CABINET

High voltage circuits are inside the monitor. Removing the cabinet may expose you to the danger of fire or electric shock.

DO NOT PUT ANY OBJECT INTO THE MONITOR

Do not put any solid objects or liquids such as water into the monitor. In case of an accident, unplug your monitor immediately and contact your dealer or iiyama service center. Using the monitor with any object inside may cause fire, electric shock or damage.

INSTALL THE MONITOR ON A FLAT, STABLE SURFACE

The monitor may cause an injury if it falls or is dropped.

DO NOT USE THE MONITOR NEAR WATER

Do not use where water may be splashed or spilt onto the monitor as it may cause fire or electric shock.

OPERATE UNDER THE SPECIFIED POWER SUPPLY

Be sure to operate the monitor only with the specified power supply. Use of an incorrect voltage will cause malfunction and may cause fire or electric shock.

PROTECT THE CABLES

Do not pull or bend the power cable and signal cable. Do not place the monitor or any other heavy objects on the cables. If damaged, the cables may cause fire or electric shock.

ADVERSE WEATHER CONDITIONS

It is advisable not to operate the monitor during a heavy thunder storm as the continual breaks in power may cause malfunction. It is also advised not to touch the plug in these circumstances as it may cause electric shock.

CAUTION

INSTALLATION LOCATION

Do not install the monitor where sudden temperature changes may occur, or in humid, dusty or smoky areas as it may cause fire, electric shock or damage. You should also avoid areas where the sun shines directly on the monitor.

DO NOT PLACE THE MONITOR IN A HAZARDOUS POSITION

The monitor may topple and cause injury if not suitably located. Please also ensure that you do not place any heavy objects on the monitor, and that all cables are routed such that children may not pull the cables and possibly cause injury.

MAINTAIN GOOD VENTILATION

Ventilation slots are provided to keep the monitor from overheating. Covering the slots may cause fire. To allow adequate air circulation, place the monitor at least 10 cm (or 4 inches) from any walls. Operating the monitor on its back, side, upside down or on a carpet or any other soft material may also cause damage.

DISCONNECT THE CABLES WHEN YOU MOVE THE MONITOR

When you move the monitor, turn off the power switch, unplug the monitor and be sure the signal cable is disconnected. If you do not disconnect them, it may cause fire or electric shock.

UNPLUG THE MONITOR

If the monitor is not in use for a long period of time it is recommended that it is left unplugged to avoid accidents.

HOLD THE PLUG WHEN DISCONNECTING

To disconnect the power cable or signal cable, always pull it by the plug. Never pull on the cable itself as this may cause fire or electric shock.

DO NOT TOUCH THE PLUG WITH WET HANDS

Pulling or inserting the plug with wet hands may cause electric shock.

WHEN YOU INSTALL THE MONITOR ON YOUR COMPUTER

Be sure the computer is strong enough to hold the weight of the monitor, otherwise, you may damage your computer.

OTHERS

ERGONOMIC RECOMMENDATIONS

To eliminate eye fatigue, do not operate the monitor against a bright background or in a dark room. For optimal viewing comfort, the monitor should be just below eye level and 40-60 cm (16-24 inches) away from your eyes. When using the monitor over a prolonged time, a ten minute break every hour is recommended as looking at the screen continuously can cause eye strain.

SPECIAL NOTES ON LCD MONITORS

④ The following symptoms are normal with LCD monitors and do not indicate a problem.

NOTE

- When you first turn on the LCD monitor, the picture may not fit in the display area because of the type of computer that is used. In this case, adjust the picture position to the correct position.
- You may find slightly uneven brightness on the screen depending on the desktop pattern you use.
- Due to the nature of the LCD screen, an afterimage of the previous screen may remain after switching the image, when the same image is displayed for hours. In this case, the screen is recovered slowly by changing the image or turning off the Power Switch for hours.

④ This LCD cannot be used outdoors.

④ This LCD cannot be used with the screen facing upwards.

④ If you use a cable longer than the supplied one, the picture quality is not guaranteed. Touch function can be disrupted if the USB cable length exceeds 3m.

USAGE CONFIRMATION

The display is compatible for usage in Landscape applications.

IMAGE PERSISTENCE / IMAGE STICKING

Please be aware that all LCD screens can experience Image Persistence or Image Sticking. This occurs when a residual image remains visible on a screen when static images are displayed for long periods of time. LCD Image Persistence is not permanent but constant images being displayed for a long period of time should be avoided.

To counteract Image Persistence, turn off the monitor for as long as the previous image was displayed, so if an image was on the monitor for 1 hour and there is evidence of a residual or “ghost” image, you should turn off the monitor for 1 hour in order to clear the residual image.

For all LFD products, iiyama recommends displaying moving images and utilising a moving screen saver at regular intervals whenever the screen is idle. You could also turn off the monitor when not in use to assist the prevention.

Other ways to reduce the risk of Image Persistence will be to utilise the FAN-on function (if available), Low Backlight and Low Brightness settings.

FOR EXTENDED USE AS A PUBLIC DISPLAY

④ Image Sticking on LCD Panel

When a static image is displayed for hours, an electric charge trace remains near the electrode inside the LCD producing a “ghost” image. (Image Persistence).

Image Persistence is not a permanent feature.

④ Recommendations

To prevent Image Sticking and promote longer life expectancy of display, we recommend the following:

1. Avoid static images displayed for long periods – change static images on continuous loop.
2. Turn off monitor when not in use, either by remote control or use Standby or Schedule functions.
3. When monitor is installed in high ambient temperature environment(s) or in an enclosed position, utilise the Cooling Fan, Screen Saver and Low Brightness functions.
4. Suitable ventilation for any monitor is an expectation of any installation – climate control systems may need to be employed.
5. We strongly recommend utilisation of active cooling with fans for long operation times or high ambient temperature environments.

CUSTOMER SERVICE

NOTE

④ If you have to return your unit for service and the original packaging has been discarded, please contact your dealer or iiyama service center for advice or replacement packaging.

CLEANING**WARNING**

- ④ If you drop any materials or liquids such as water into the monitor when cleaning, unplug the power cable immediately and contact your dealer or iiyama service center.
- ④ For safety reasons, turn off the power switch and unplug the monitor before you clean it.

CAUTION

- ④ Do not spray alcohol or disinfectants directly onto the monitor or use them near the monitor. Also, do not wipe the monitor with a cloth or sheet that contains alcohol or disinfectants. These may cause discoloration, deterioration, or cracking of the cabinet, damage to the surface treatment of the Touch Panel, and deterioration of components.
- ④ To avoid potential damage on the monitor (Touch Panel / cabinet / connector terminals) or accessories, never use the following strong solvents or cleaning sheets. These may cause discoloration, deterioration, or cracking of the cabinet, damage to the surface treatment of the Touch Panel, and deterioration of components.

Benzine	Hypochlorous acid water
Thinner	Acidic or alkaline solvents
Alcohol	Wax
Bleach	Abrasives
Peroxide	Office equipment cleaner
Acetone	Glass cleaner
Methylene chloride	Tissue paper
Toluene	Wet tissue
Ammonia	Chemical cloth
Sodium hypochlorite solution (Chlorine bleach)	Cleaning paper
	etc.

NOTE

- ④ To protect the Touch Panel, do not scratch or rub the screen with a hard object.
- ④ Do not leave the Touch Panel wet. If water droplets or the like get on it, immediately wipe it off with a dry, soft cloth. Leaving it on may cause discoloration or stains on the Touch Panel. In addition, if moisture gets inside the monitor, it may cause damage.
- ④ Touching the cabinet with any product made from rubber or plastic for a long time may cause degeneration or loss of paint on the cabinet.

Regular care

Gently wipe the cabinet with a soft, dry and clean cloth. If your monitor is particularly dirty, soak the cloth in a mild detergent thoroughly diluted with water, wring it out tightly, and then wipe the dirt off. Then immediately wipe it with a soft, dry cloth.

Alcohol disinfection

Alcohol disinfection may cause discoloration, deterioration, or cracking of the cabinet, damage to the surface treatment of the Touch Panel, and deterioration of components. Instead, we recommend disinfecting your hands away from the monitor before and after use.

If you absolutely must disinfect the monitor with alcohol, please understand above warnings and cautions in advance. Also, avoid frequent alcohol disinfection.

BEFORE YOU OPERATE THE MONITOR

FEATURES

- ④ Supports Resolutions up to 3840 × 2160
- ④ High Contrast 1200:1 (Typical: without glass) / Brightness 450cd/m² (Typical, panel) : ProLite TE5513A / ProLite TE9813A
- ④ High Contrast 1200:1 (Typical: without glass) / Brightness 500cd/m² (Typical, panel) : ProLite TE6513A / ProLite TE7513A / ProLite TE8613A
- ④ Digital Character Smoothing
- ④ Automatic Set-up
- ④ USB Type-C / RJ45 Connectors
- ④ USB Power Delivery supports up to 100W
- ④ 2 × 20W (Typical) Stereo Speakers + 1 × 20W (Typical) Subwoofer
- ④ VESA Mounting Standard (800mm×600mm) Compliant : ProLite TE9813A / ProLite TE8613A
- ④ VESA Mounting Standard (800mm×400mm) Compliant : ProLite TE7513A
- ④ VESA Mounting Standard (600mm×400mm) Compliant : ProLite TE6513A
- ④ VESA Mounting Standard (400mm×400mm) Compliant : ProLite TE5513A
- ④ Glass with AG coating & Anti-Bacteria
- ④ NFC reader
- ④ HALL sensor
- ④ PIR sensor

CHECKING THE CONTENTS OF THE PACKAGE

The following accessories are included in your package. Check to see if they are enclosed with the monitor. If anything is missing or damaged, please contact your local iiyama dealer or regional iiyama office.

- | | |
|-------------------------------|---|
| ④ Power Cable* | ④ Cable ties (For cable management, 6pcs) |
| ④ HDMI Cable | ④ Mounting bracket for webcam (1set) |
| ④ Touch USB Cable | ④ Wall mount kit |
| ④ Remote Control | ④ Antenna (3pcs) |
| ④ Battery (2pcs) | ④ Quick Start Guide |
| ④ Touch Pen (Dual head: 4pcs) | ④ Safety Guide |

CAUTION

- * All guarantees and warranties are void for any problems or damage caused by a power cable not supplied by iiyama.
An approved power cable greater or equal to H05VVf, 3G, 0.75mm² must be used.

UNPACKING

CAUTION

Moving the monitor requires at least two people. If not, it may drop and could result in a serious injury.

SPECIAL NOTES ON THE TOUCH PANEL

CAUTION

Permanent damage can occur if Sharp Edged, Pointed or Metal items are used to activate Touch. This could invalidate any remaining warranty.

We recommend you use a plastic stylus (tip \varnothing 3mm or over) or finger.

INSTALLATION

CAUTION

- ④ Follow the manual instructions for the type of mount you have selected. Refer all servicing to qualified service personnel.
- ④ Moving the monitor requires at least two people.
- ④ Before installation, please make sure the wall is strong enough to hold the necessary weight of the display and the mount.

ENGLISH

[WALL MOUNTING]

CAUTION

Use four M8 x 25 mm screws to fix a VESA mounting bracket to the monitor. Make sure that all screws are tightened and secured properly.

When using the wall mounting, consideration of thickness of the VESA mounting bracket needs to be taken. The thickness of the VESA mounting bracket is assumed to be approx. <math><2.5\text{mm}</math>.

Using a screw longer than this may cause electric shock or damage because it may contact with the electrical parts inside the monitor.

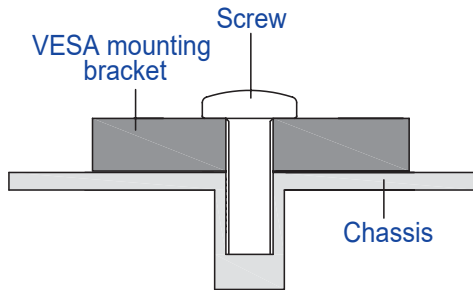

[INSTALLATION NOTE]

The touch kit of this monitor is an optical device that utilizes infrared light source and sensitive sensors for touch detection.

Notice the incident light that contains large quantities of infrared light may affect touch screen operation and performance.

Please install it with care as follows to ensure reliable touch performance.

Intense light / Specular light / Focus spotlight / Wide spread light / Direct sunlight / Indirect sunlight from the window and/or the glass door. / Not install the touch monitor right under the light source.

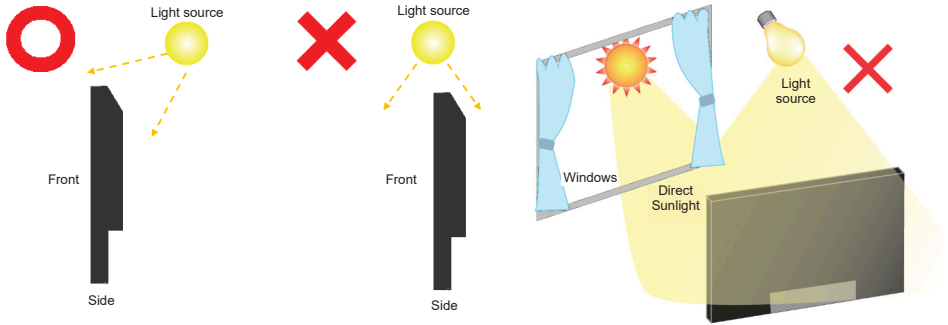

[ROTATING THE DISPLAY]

It is designed to be compatible in landscape mode.

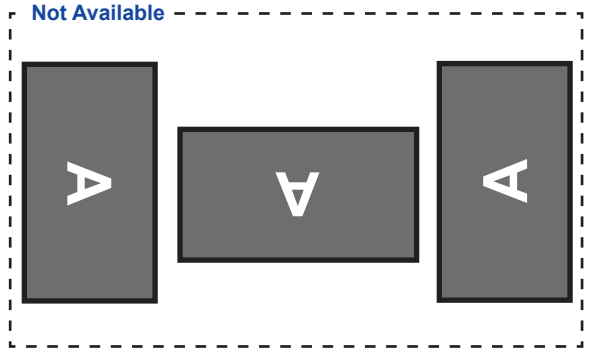
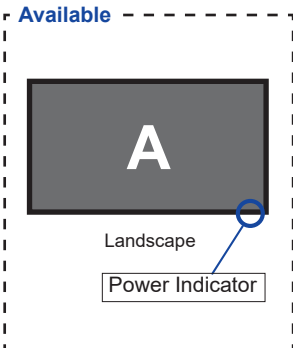

CONTROLS AND CONNECTORS : MONITOR

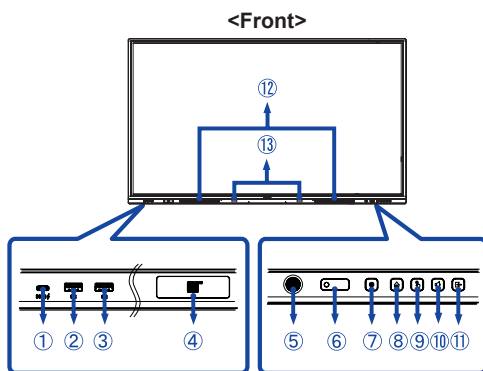

①	USB-C 3.2 (Public)	USB-C3.2 Gen 1: 5Gbps, 5V, 3A / 9V, 3A / 12V, 3A / 20V, 5A	TE9813A: USB-C3.2 Gen 1: 5Gbps, (5V, 3A / 9V, 1.67A)	USB-C Connector
② ③	USB 3.2 (Public)	USB3.2 Gen 1: 5Gbps,5V, 900mA	USB Connector	
④	NFC		NFC Sensor	
⑤	PIR Sensor		PIR Sensor	
⑥	Remote/Light Sensor		Remote/Light Sensor	
⑦	Power Button		Power Off Pressing and holding the Power Button on the front for 3-5 seconds. Screen Off A short press.	
	Power Indicator	White	Normal Operation	
		Red	Standby Mode When the power indicator light is lighting red, the display is in Power Save Mode. To turn the screen back on, you can press the power button on the front or the remote control.	
		Red & White Flashing slow	The Screen Off function is active. To turn the screen back on, you can touch the screen or any button on the remote control.	
	Red & White Flashing fast	Going to the Standby Mode or system is updating.		
⑧	HOME * ¹		Home Button / Device menu	
⑨	TOUCH-FREEZ		Touch / Disable Touch Button	
⑩	VOLUME * ²		Volume Button / Mute	
⑪	INPUT		Input Button	
⑫	SPEAKERS		Speakers	
⑬	Hall Sensor * ³		Hall Sensor	

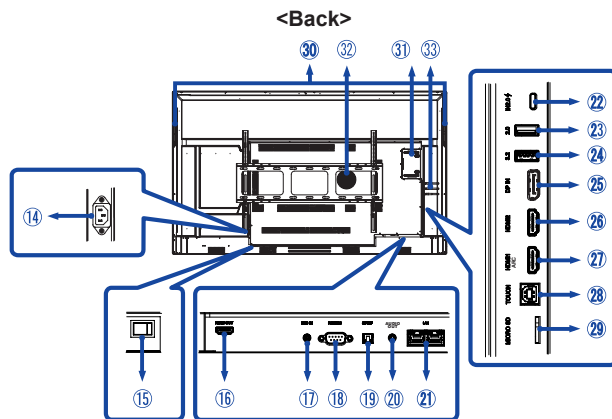

⑭	AC IN	AC-INLET	AC Connector(~ : Alternating current) (AC-IN)
⑮	AC SWITCH (ON) / ○ (OFF)	MAIN POWER	Main Power Switch
⑯	HDMI OUT	HDMI	HDMI Connector
⑰	MIC IN	Mini Jack	MIC Connector
⑱	RS232C	RS232C 9pin	RS232C Connector
⑲	SPDIF	SPDIF	SPDIF Connector
⑳	AUDIO OUT *4	Mini Jack	Audio Out Connector
㉑	LAN	RJ45	RJ45 Connector (This network port is only used for Android system)
㉒	USB-C 2.0 (Public)	USB2.0 480Mbps, (5V, 3A / 9V, 3A / 12V, 3A / 20V, 3.25A)	USB-C Connector
㉓	USB 2.0 (Public)	USB2.0 5V, 500mA	USB Connector
㉔	USB 3.2 (Android)	USB3.2 Gen 1: 5Gbps,5V, 900mA	USB Connector
㉕	DP IN	DispalyPort	DispalyPort Connector
㉖	HDMI2 IN	HDMI(A)	HDMI Connector
㉗	HDMI1 IN (ARC) *5		
㉘	TOUCH	USB-B	Touch USB Connector
㉙	MICRO SD	MICRO SD	MICRO SD Slot
⑳	HANDLES		Handles
㉑	Option PC module slot		Option PC module slot
㉒	SUBWOOFER	Subwoofer	
㉓	Antenna Connector (Antenna x 3 in Accessory)		Antennenstecker

*1 Device menu: Press and hold HOME button for 2 seconds.

*2 Mute: Press and hold Hold VOLUM button for 2 seconds.

*3 Not available ProLite TE5513A.

*4 It is not supported to use a headset with this port.

*5 The HDMI ARC function is only available when you enable CEC. The connected device (e.g. soundbar) needs to have/support HDMI ARC.

FUNCTIONS OF THE REMOTE CONTROL

ENGLISH



*UC-CAM10PRO-1 and UC-CAM10PRO-MA1 manufactured from March 2025 onwards will support this feature. Products manufactured prior to this date will require a firmware upgrade.

①		Turn the monitor ON and OFF.
②	Number (1-9) / Other / Keyboard function	Under iiWare: 0-9 numeric input Under Windows: 0-9 numeric input, Start/Space/ALT+Tab/ALT+F4 for Keyboard function
③	Display	Provide source and resolution information.
④	Home	System main screen button.
⑤	Input	Select the source.
⑥	Screen Off	Turn the backlight On and Off.
⑦		Navigate through submenus and settings. ▲: Up Button ▼: Down Button ◀: Left Button ▶: Right Button
	OK	Confirm your selection or save changes.
⑧		Quickly start "Writing Software".
⑨	PgUp / PgDn	When select File: The first / Last When Internet browser: Scroll Up / Scroll Down
⑩	Lift + / Lift -	Lift + : Electric Lift Move up Lift - : Electric Lift Move down
⑪	Green	Lock and unlock Buttons function.
⑫	Red	Lock and unlock Buttons and Touch function.
⑬	Webcam *	: Camera off, : Mic off, ^<> & OK : Adjust the position of field of view, ↵ : Return, A/M : Auto Framing/Manual, Q / Q : Zoom in / out, ≡ : OSD menu
⑭		Turn on or off the mute function when the Menu is not displayed.
⑮		Not available on this model.
⑯	MENU	Display the "Device menu"
⑰		Backspace
⑱	Back	Return to a previous menu or closes the OSD Menu.
⑲	VOL+ / VOL-	VOL+: Increase the sound volume. VOL-: Decrease the sound volume.
⑳	Yellow	Lock and unlock Touch function.
㉑	Blue	Freeze the picture.

PREPARING THE REMOTE CONTROL

To use the remote control, insert the two dry batteries.

CAUTION

- ④ Do not use any other batteries other than those specified in this manual for the Remote Control.
 - ④ Do not insert old and new batteries together in the Remote Control.
 - ④ Make sure that the terminals match the "+" and "-" indications in the battery compartment.
 - ④ Remove the dead batteries immediately to prevent them from liquid leaking into the battery compartment.
 - ④ Burst batteries or the electrolyte from these batteries may cause stains, fire or injury.
- ① Open back cover of battery component on the back of remote control.

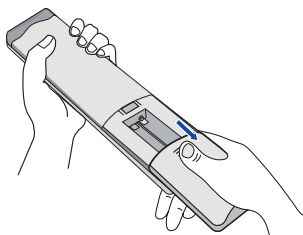

- ② Align and insert two AAA batteries according to their plus and minus ports (as indicated in the remote control).

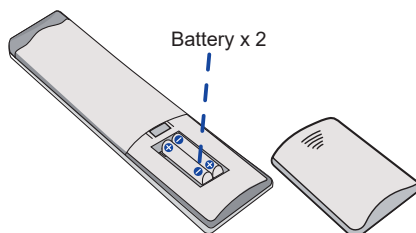

- ③ After battery is installed, close the back cover of battery components, and make the following clip buckled to the bottom.

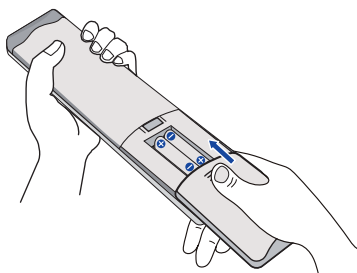

NOTE

- ④ Refer to the above instructions when taking out the batteries.
- ④ Replace with new batteries when the Remote Control does not work close to the monitor. Use AAA dry batteries. Risk of explosion if battery is replaced by an incorrect type.
- ④ Operate the Remote Control by pointing it toward the Remote Sensor on the monitor.
- ④ Other manufacturers remote control will not work with this monitor. Use the provided Remote Control ONLY.
- ④ Used batteries needed to follow the city rule to be discarded. (suggestion: to dispose of used batteries please follow correct policy as per your council regulations)
- ④ Batteries shall not be exposed to excessive heat such as sunshine, fire or the like.
- ④ If you do not intend to use the remote control for a long period, remove the batteries.

BASIC OPERATION

④ Turning the monitor ON

The monitor is turned On and the Power Indicator turns to White when you press the Power Button on the monitor or the Remote Control. The monitor is turned Off and the Power Indicator turns to Red when you press the Power Button on the monitor or the Remote Control. Press again to turn On the monitor.

NOTE

Even when using the standby mode or turning OFF the Power Switch, the monitor will consume a small amount of electricity. Turn OFF the Power Switch or disconnect the Power Cable from the power supply whenever the monitor is not in use or during the night, to avoid unnecessary power consumption.

[Monitor]

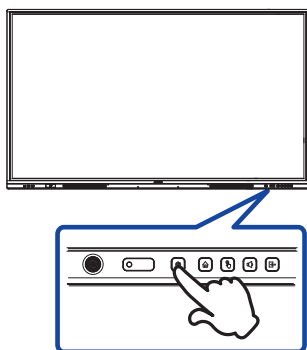

[Remote Control]



④ Display the device menu page

The device menu page appears on the screen when you press the Menu Button on the Remote Control. The device menu page disappears when you press the Back Button on the Remote Control.

[Remote Control]



④ **Move the cursor vertically**

Select adjustment by pressing the ▲ / ▼ Button on the remote control while the menu page is displayed on the screen.

[Remote Control]



④ **Move the cursor horizontally**

Select menu or setting, or perform the adjustment by pressing the ◀ / ▶ Button on the remote control while the menu page is displayed on the screen.

[Remote Control]



④ Adjust the volume of sound

Press the VOL- / VOL+ Button on the remote control to adjust the volume of sound when the menu page is not displayed on the screen.

[Remote Control]



④ Switch the input signal

The Input setting menu appears on the screen when you press the Input Button on the remote control.

[Remote Control]



CONNECTING YOUR MONITOR

- ① Ensure that both the computer and the monitor are switched off.
- ② Connect the computer to the monitor with the signal cable.
- ③ Connect the computer to the monitor with the Touch USB Cable.
- ④ Connect the computer to the monitor with the USB Type-C Cable when viewing images on your monitor through the USB Type-C Connector or when using the monitor's USB hub function.*
- ⑤ Connect the Power Cable to the monitor first and then to the power source.
- ⑥ Turn on your monitor (Main Power Switch and Power Button) and computer.

⌘ * When charging connected device via USB Type-C Connector, check if the device is equipped with a USB Type-C Connector that supports charging function via USB PD (=Power Delivery).

⌘ The connected device can be charged via USB Type-C Connector even when the monitor is in standby mode.

⌘ The USB power delivery is up to 100W. If the connected device required more than 100W for operation or for boot up (when the battery is drained), use the original power adapter that came with the device.

⌘ If a separately purchased USB Type-C Cable is used, make sure the cable is certified by USB-IF and is full-featured with power delivery and video / audio / data transfer functions.

⌘ USB C to A cable is not included with the monitor. If you use a USB C to A cable, please note that you can only transfer data.

⌘ Compatibility with all connected devices is not guaranteed due to different user environments.

NOTE

- ④ Make sure that the building installation has a circuit breaker of 120/240V, 20A (maximum).
- ④ The signal cables used for connecting the computer and monitor may vary with the type of computer used. An incorrect connection may cause serious damage to both the monitor and the computer. The cable supplied with the monitor is for a standard connector. If a special cable is required please contact your local iiyama dealer or regional iiyama office.
- ④ Make sure you tighten the finger screws at each end of the Signal Cable.
- ④ The touch function is ready for use about 5 seconds after connecting the USB cable and can be operated with a pen, finger or any other pointer.
- ④ The Class I pluggable equipment Type A must be connected to protective earth.
- ④ The socket-outlet shall be installed near the equipment and shall be easily accessible.
- ④ Excessive sound pressure from ear/headphones can cause hearing damage/hearing loss.

[Example of Connection]

<Back>

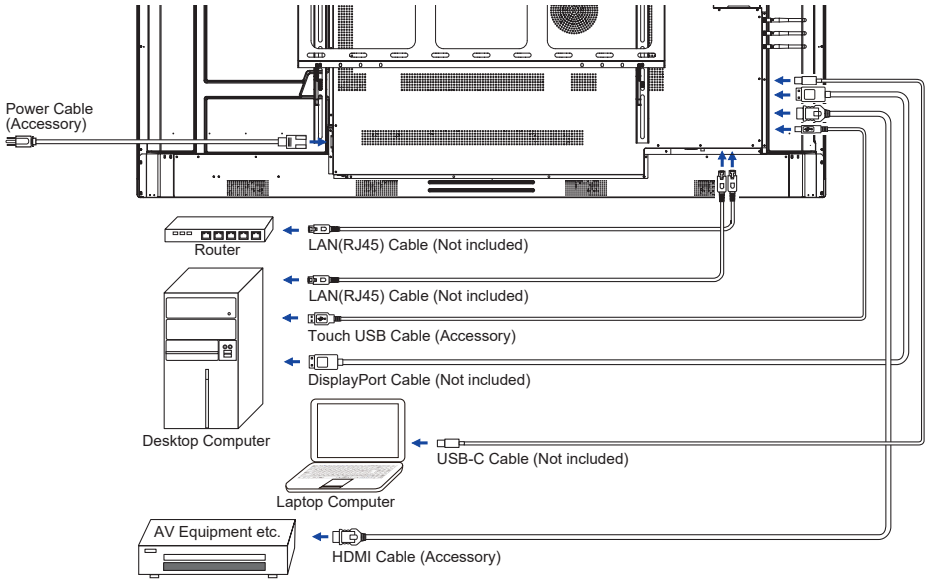

[Connection example with the peripheral device]

CAUTION

Turn off the power switch and unplug the monitor and peripherals before connection to avoid an electric shock or a damage.

NOTE

- ④ Refer to the user manual of peripherals at the same time.
- ④ Ensure you have the necessary cables as required.

ENGLISH

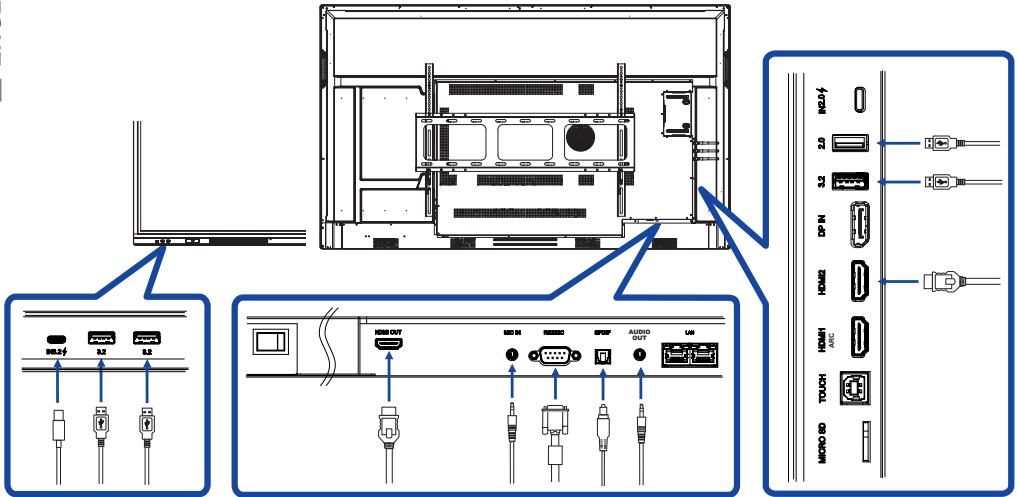

COMPUTER SETTING

④ Signal Timing

Change to the desired signal timing listed on page 65: COMPLIANT TIMING.

④ Procedure for turning ON the Power Switch

Turn ON the monitor first, and then the computer.

④ MULTI-TOUCH :

This monitor complies with DDC2B of VESA standard. (Plug&play compliant)

The MULTI-TOUCH function runs on Windows7/8/8.1/10/11 by connecting the monitor to DDC2B compliant computer with the USB cable supplied.

④ TOUCH support operation system :

- Microsoft Windows 2000 (64 bit and 32 bit)
 - Microsoft Windows XP (64 bit and 32 bit)
 - Microsoft Windows Vista (64 bit and 32 bit)
 - Microsoft Windows 7 (64 bit and 32 bit)
 - Microsoft Windows 8/8.1/10/11 (64 bit and 32 bit)
 - Mac OS X V13.1 & higher HID for single touch only
 - Linux 3.0 & higher need patch for multi-touch
3.5 & higher HID for multi-touch
- Not support Windows earlier versions.

	Windows 7*5,8/8.1*6,10*6,7,8,11*6,7,8	Windows7*4	Vista	XP	2000	Mac OSX	Linux
Default mouse*1	○	○	○	○	○	○	○
Touch digitizer*2	○	○	○	×	×	×	×
Windows gestures*3	○	×	×	×	×	×	×

*1 Default mouse (click, drag, double-click and right-click)

*2 Touch digitizer (click, drag /selection, double-click, right-click, flick and visual feedback)

*3 Digitizer with Windows7/8/8.1/10 multi-touch gestures

*4 Windows 7 - Starter and Home Basic version

*5 Windows 7 - Home Premium, Professional, Enterprise and Ultimate versions

*6 Windows 8/8.1/10/11 need non-OEM version for multi-touch support



*7 Windows10/11 - Home, Pro, Enterprise, Education, IoT Core

Not supported for Mobile and Mobile Enterprise.

*8 Windows10/11 - Touch do no support for “touchpad gestures”. Touchpad gesture is for touchpad on notebook.

OPERATING THE MONITOR



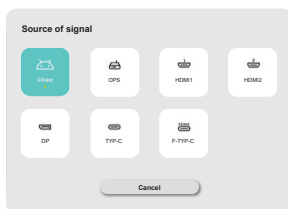

To create the best picture, your iiyama LCD monitor has been preset at the factory with the COMPLIANT TIMING shown on page 64. You are also able to adjust the picture by following the button operation shown below.

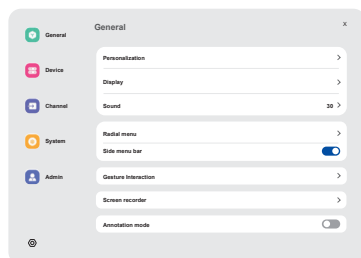

- 1 Use the touch pen to call up source menu click the  icon at the sidebar of the screen. Or press Input Button on the remote control. You can also access the Device menu by clicking  on the desktop.





- 2 Start the On Screen Display feature. There are additional Menu items which can be switched by using the  /  Buttons on the remote control or with the touch pen.



- 3 Select the Menu item of the adjustment you want to make. Use the  /  Buttons on the remote control or with the touch pen to highlight the desired adjustment item. Then, press the Enter button on the remote control.
- 4 Use the  /  Buttons on the remote control or with the touch pen to make the appropriate adjustment or setting.
- 5 Press the Back Button on the remote control or click blank area outside menu with the touch pen to exit menu.

For example, to correct for Backlight, select Menu item of "Display". Select "Backlight" by using the  /  Buttons on the remote control or with the touch pen.

Use the  /  Buttons on the remote control or with the touch pen to change the Backlight settings. The brightness of the overall display should be changing accordingly while you are doing this.

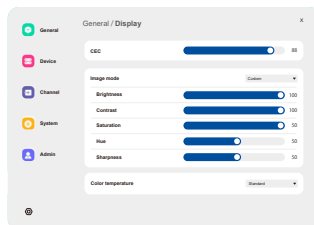

Press the Back Button on the remote control or click blank area outside menu with the touch pen, it ends, all changes are saved in the memory.

NOTE

- ④ The Back Button on the remote control can be used to return previous menu item.
- ④ Any changes are automatically saved in the memory when the On Screen Display disappears. Turning off the power should be avoided while using the Menu.
- ④ Adjustments for Image Position and Phase are saved for each signal timing. Except for these adjustments, all other adjustments have only one setting which applies to all signal timings.

Direct

* Available for Remote Control only.

⌘ Freeze Function:

Press the Blue button when Menu is not displayed.
Repeat successively to activate/deactivate the function.

⌘ Backlight Function:

Press the Screen Off button when Menu is not displayed.
Repeat successively to On/Off the function.

⌘ Input Function:

Press the Input Button when Menu is not displayed.

⌘ Volume Function:

Press the VOL+/VOL- Buttons when Menu is not displayed.

⌘ Mute Function:

Press the  Button when Menu is not displayed.
Repeat successively to On/Off the function.

[LOCK MODE]**⌘ Front All Buttons:**

Press the Green Button when Menu is not displayed, will lock/unlock the Front All Buttons.

⌘ Touch function:

Press the Yellow Button when Menu is not displayed, or use Front Touch-Freeze Buttons.

⌘ Front Power Button & Touch function:

- ④ Press the Red Button when Menu is not displayed, will lock/unlock the Front All Buttons and Touch function.

SOURCE OF SIGNAL

Source of signal		Source of signal	
Adjustment Item	Problem / Option		
Input *1 Direct	iiWare	Select the iiWare input.	
	OPS*2	Select the OPS input.	
	HDMI1	Select the HDMI1 input.	
	HDMI2	Select the HDMI2 input.	
	DP	Select the DP input.	
	Type-C	Select the Type-C input.	
	F-Type-C	Select the F-Type-C input.	









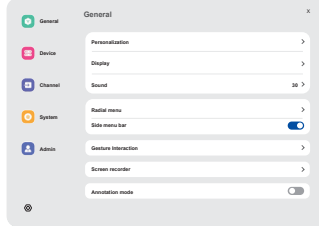

*1 The switching of the signal input take a few seconds.

*2 Available when PC is installed only.

DEVICE MENU

General









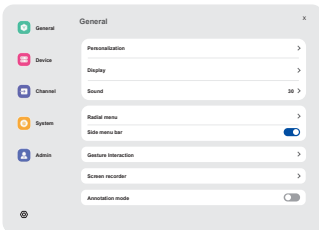



Adjustment Item	Problem / Option		Button to Press	
Personalization	Theme	System provides 2 sets of themes (conference theme/ education theme) by default.		
	Wallpaper	System provides 2 wallpapers by default, user can add Wallpapers.		
	Auto loop	turn on auto loop, wallpapers will be switched automatically in 20 seconds interval.		
Display	Backlight *	Too dark Too bright		
	Image mode	Standard	For general windows environment and monitor default setting.	
		Bright	Enlarge brightness and vivid.	
		Briilliant	Reduce brightness and soften.	
		Custom	Displays a picture on a screen set by Image Settings adjustments.	
	Brightness	Too dark Too light		
				
	Contrast	Too dull Too intense		
				
	Saturation	Too weak Too strong		
				
	Hue	Purplish Greenish		
				
Sharpness	Too soft Too sharp			
				
Color Temperature	Standard	Normal color		
	Warm	Warm color		
	Cold	Cool color		
Eye protection mode	Turn on or off eye protection mode.			
Energy saving	Turn on or off energy saving.			

* Adjust the Backlight when you are using the monitor in a dark room and feel the screen is too bright.

General



Adjustment Item	Problem / Option		Button to Press	
Sound	Volume Direct	Too soft Too loud	 	
	Max volume	Set the maximum volume output by the system	 	
	Equalizer	Reset the volume balance value.		
	Balance	Left side speaker louder Right side speaker louder	 	
	Sound mode	Standard	Standard sound quality.	
		Meeting	Sound quality suitable for the conference.	
		Cinema	Sound quality suitable for the cinema.	
		Classroom	Sound quality suitable for the classroom.	
Custom	Custom sound quality.			
Bass	Too weak Too strong	 		
Treble	Too weak Too strong	 		
Radial menu	When enabled, the radial menu will be displayed on any interface. When disabled, the radial menu can't be summoned via gestures. (see page 41 for details)			
	Close menu after no action	When turned on, you can set the corresponding fold time to either 5 seconds or 20 seconds.		
Side menu bar	<input type="radio"/>	Turn on the side menu bar.		
	<input type="checkbox"/>	Turn off the side menu bar.		
Gesture Interaction	Activate radial menu	When enabled, you can activate the radial menu by long-pressing the IFPD interface with five fingers.		
	Sleep	When enabled, you can lock the screen with a double-tap using two fingers.		
	Go back	When enabled, you can swipe left with two fingers to go back.		
Screen recorder	Resolution	Two resolution options are provided for selection, 1280*720 or 1920*1080.		
	Max time	longest recording duration Short recording duration		
	Audio source	You can set the audio source to be media sound, microphone sound, or a combination of both media and microphone sounds.		
Annotation mode	When turned on, Annotation mode with a pen can appear handwriting, while using the hand can operate the interface.			

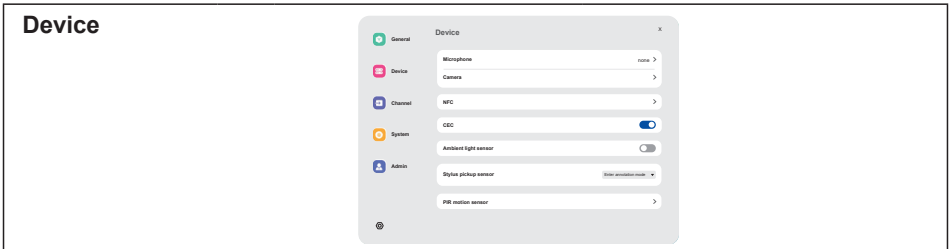

Adjustment Item	Problem / Option	Button to Press	
Microphone	You can select the microphone to use in the microphone device connected to the machine and test whether the microphone input is normal.		
Camera	You can select the camera to use from the camera device connected to the machine and display a preview of the camera.		
NFC *	<input type="radio"/>	Turn on the NFC module of the device. Once enabled, new NFC cards can be added.	
	<input type="checkbox"/>	Turn off the NFC module of the device.	
	Shutdown by NFC		Enabled / Disabled
	Boot by NFC		Enabled / Disabled
	Wakeup by NFC		Enabled / Disabled
CEC	Once enabled, a function realised through the HDMI interface, allowing control and communication between connected devices. Currently only one-way CEC function is supported.		
Ambient light sensor	When turned on, the screen's backlight brightness will automatically adjust according to the ambient light.		
Stylus pickup sensor	When enabled, if a pen-lifting action is detected, three quick access buttons for whiteboard, annotation, and no action will appear.		
PIR motion sensor	When enabled, the screen will automatically wake up when someone approaches the device.		

* Support NFC reader ISO/IEC 14443 A, ISO/IEC 14443 B, ISO/IEC 15693, MIFARE 1K / 4K, MIFARE DESFire, Sony FeliCa (According to ISO/IEC 18092 (Ecma 340) standard.)

Channel

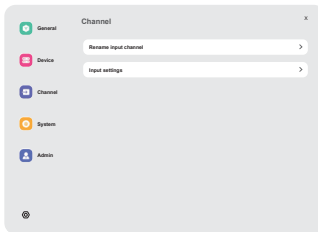

Adjustment Item	Problem / Option	
Rename input channel	iiWare OPS HDMI1 HDMI2 DP Type-C F-Type-C	Users can customize the names of the input source channels. After customization, the system will display the newly defined source names.
Input settings Direct	Source lost detection Auto source switch Auto wakeup OPS boot with system Power on source	If a signal source failure is detected, the page will automatically switch. Users can customize which page to jump. When the system is running and a new signal source is connected, it will automatically switch to display the new input. Not support for Type C / F- Type C When the device is in standby or sleep mode, connecting a signal source will automatically wake up the device. When enabled, the device will automatically power on when the OPS module is powered. Set the default input channel that appears each time the device is turned on. This can be set to the last used channel (memory channel), iiWare, OPS, HDMI1, HDMI2, DP, TYPE-C, F-TYPE-C.

System

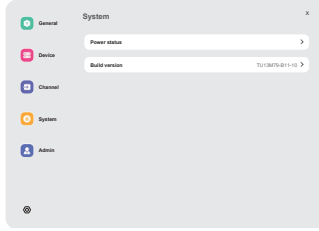

Adjustment Item	Problem / Option	
Power status	Power on status	optional power on, power on standby, power on last
	Screen off after no operation	If there is no operation within the specified time, the device will automatically screen off. (Never / 15 mins / 30 mins / 60 mins / 90mins / 120 mins)
	Standby after no operation	If there is no operation within the specified time, the system will go into standby mode automatically. (Never / 30 mins / 60 mins / 90mins / 120 mins / 240 mins)
	Standby after no signal	If there is no signal input within the specified time, the system will go into standby mode automatically. (Never / 1 mins / 3 mins / 5 mins / 10 mins / 15 mins / 30 mins / 45 mins / 60 mins)
	Temperature detection	Turn on or off temperature detection.
	High temperature protection	Machine will automatically power off when The temperature is too high.
	Scheduled power-on / power-off	Scheduled power-on Scheduled power-off
Build version	FW version	

Admin

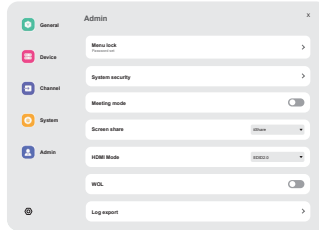

Adjustment Item	Problem / Option	
Menu lock	The administrator can set a six-digit password when entering for the first time, and after setting it, users need to enter the corresponding password to enter the administrator page again.	
System security	USB permissions	When it is turned on, third-party applications will not be able to access the usb stick.
	Channel Permission	When it is turned on, a password is required to enter the signal source channel
	App lock	When it is turned on, a password is required to enter the application.
	Unknown sources	When it is turned on, it will allow other apps to install third-party APP.
Meeting mode	When it is turned on, no signal standby only resting screen, users can touch the screen to wake up the big screen.	
Screen share	You can choose to use iiShare or EsharePro	
HDMI Mode	Users can switch the HDMI mode to EDID1.4 or EDID2.0.	
WOL	When turned on, the device allows users to wake up the device by sending Magic Packet via LAN when the device is switched off.	

[Application]

④ Settings

You can access the Menu by clicking  on the desktop and clicking  on the left corner.

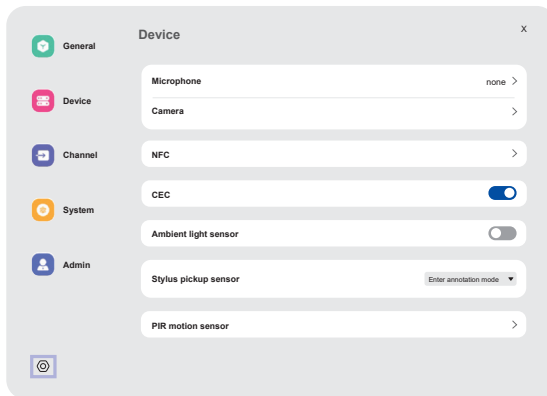
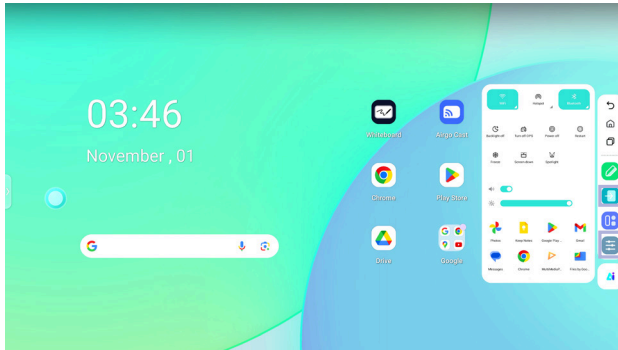

Search

Network & internet
Wi-Fi, hotspot

Connected devices
Bluetooth, pairing

Apps
Recent apps, default apps

Notifications
Notification history, conversations

Storage
13% used - 111 GB free

Sound & vibration
Volume, vibration, Do Not Disturb

Display
Dark theme, font size, brightness

Network & internet

Internet
To switch networks, disconnect ethernet

Hotspot & tethering
Off

Data Saver
Off

VPN
None









Private DNS
Automatic

 XXXXXX :

When connecting a LAN or Option WiFi module, the password for a notebook or a smartphone, etc. to connect to iShare, is displayed on the screen. (Automatically generated)

Adjustment Item	Problem / Option		
Network & internet	Internet	Ethernet Set the wired network. Ethernet : On / Off, Local network setting, IP address, Default gateway, Netmask, DNS, Proxy, MAC address	
		Wi-Fi *1 Set the WiFi function On / Off and pairing to WiFi device.	
		Saved networks Save wifi networks on this monitor.	
		Network preferences Turn on Wi-Fi automatically / Notify for public networks / Install certificates / Wi-Fi Direct	
		Non-carrier data usage The data consumption on the monitor that does not occur through the carrier's network.	
	Hotspot & tethering	Wi-Fi hotspot *2,3 Set the Hotspot and tethering function. Use Wi-Fi hotspot: On/Off, Hotspot Name, Security, Hotspot password, Extend compatibility: On/Off	
	Data Saver	Reduces data consumption on the monitor. Use Data Saver : On / Off, Unrestricted data	
	VPN	Set the VPN.	
	Private DNS	Select Private DNS Mode. Off / Automatic / Private DNS provider hostname	
Connected devices	Pair with multiple devices or select from saved pairings. Other devices / Saved devices		
	Connection preferences	Set preferences for various connectivity options. Bluetooth / NFC / Cast / Android Beam / Printing / Nearby Share	
Apps	Application management Default apps, Screen time, Unused apps, Special app access		
Notifications	App Notifications	Control notifications from individual apps.	
	Notification history	Display recent notifications and snoozed notifications.	
	Conversations	Display the conversations labeled with priority or modified.	
	Bubbles	Display the conversations as floating icons on top of other apps.	
	Device & app notifications	Control which apps and devices can read notifications.	
	Notifications on lock screen	Set the notifications displayed on the locked screen of the monitor.	
	Do not disturb	Disable / Enable the interruption function.	
		People	Set people, apps, alarm and other interruptions causing disturbance not to display notifications.
Apps			
Alarms & other interruptions			
Schedules	Disable / Enable interruption function during sleeping mode and events.		

[Ⓞ Settings]

Adjustment Item	Problem / Option		Button to Press	
Storage	Display and adjust the device storage. Storage manager, Free up space			
Sound & vibration	Media volume	Too soft Too loud	   	
	Do not Disturb	(Please refer to the "Do not Disturb" setting in the "Notifications" options.)		
	Live Caption	Detects speech on your device and automatically generates captions. Languages, Hide profanity, Show sound labels, Live Caption in volume control		
	Media	Pin media player	Disable / Enable for quick resumption of playback, as the media player remains accessible in the Quick Settings menu.	
		Show media on lock screen	Disable / Enable the quickly resume playback, media player stays open on lock screen.	
		Show media recommendations	Disable / Enable the display of media content recommendations based on your usage patterns and preferences.	
	Default notification sound	Select the sound that will play for notifications by default.		
	Default alarm sound	Select the sound that will play for alarm by default.		
	Screen locking sound	Disable / Enable the sound that plays when the screen is locked.		
	Charging sounds and vibration	Disable / Enable the sounds and vibration when the device is being charged.		
Tap & click sounds	Disable / Enable the sounds that play when you touch the screen.			
Display	Brightness level	Too dark Too bright	   	
	Lock screen	Set the information or features displayed on the lock screen. Privacy, Add users from lock screen, Add text on lock screen, Show wallet, Show device controls, Control from locked device, Double-line clock		
	Screen timeout	Set the Screen timeout duration. (15 seconds / 30 seconds / 1 minute / 2 minute / 5 minute / 10 minute / 30 minute / Never)		
	Dark theme	Disable / Enable the dark theme mode for the display interface.		
		Set when the dark theme mode is activated. (None / Turns on at custom time / Turns on from sunset to sunrise)		
Colors	N/A			

Adjustment Item	Problem / Option		
Display	Screen saver	Disable / Enable Screen saver. Clock / Colors / Landscape / Photos	
		Set the Screen Saver duration. (Never / 15 min / 30 min / 60 min / 90min)	
	Wakeup on Input Source	Disable / Enable	
	Wakeup on Touch	Disable / Enable	
Power off timeout	Set the Power off duration. (1 hour / 12 hour / 24 hour)		
Wallpaper	Photos	Disable / Enable the use of photo album.	
	Wallpaper & style	Disable / Enable the use of themed icons.	
Accessibility	Display size and text	Set the font and display size.	
		Bold text	Disable / Enable bold text.
		High contrast text	Disable / Enable high contrast text.
		Reset settings	Display size and text settings will be restored to factory-preset data.
	Color and motion	Color inversion	Disable / Enable (Color inversion / Color inversion shortcut.
		Dark theme	(Please refer to the "Dark theme" setting in the "Display" options.)
		Color correction	Disable / Enable Color correction. Red-green / Red-green / Blue-yellow / Grayscale Disable / Enable the "Color correction shortcut".
		Remove animations	Reduce movement on the screen.
		Large mouse pointer	Make the mouse pointer more noticeable.
	Magnification	Magnification shortcut	Disable / Enable the "Magnification shortcut".
		Magnification type	Select how to magnify. Magnify full screen / Magnify part of screen / Switch between full and partial screen
		Magnify typing	Magnifier follows text as you type.
	Switch access	Disable / Enable Control device with switches or front camera	
	Timing controls	Touch & hold delay	Sets the duration required for a tap on the screen to be recognized as a touch & hold action. (Short / Medium / Long)
		Time to take action (Accessibility timeout)	Select the duration for displaying temporary messages prompting you to take action. (Default / 10 seconds / 30 seconds / 1 minute / 2 minutes)
Autoclick (dwell timing)		Set the cursor to take action automatically when the cursor remains stationary for a specified duration. (Autoclick off / short / Medium / Long / Custom)	

[@ Settings]

Adjustment Item	Problem / Option		
Accessibility	System controls	System navigation	Set how you navigate the system. (Gesture navigation / 3-button navigation / Traditional navigation)
	Live Caption	Use Live Caption	Disable / Enable Live Caption.
		Settings	Languages, Disable / Enable (Hide profanity / Show sound labels / Live Caption in volume control)
	Caption preferences	Caption preferences	Disable / Enable Caption.
		Caption size and style	Set captions size and style.
		More options	Set captions language.
	Audio description	Disable / Enable Audio description.	
	Hearing devices	For hearing aids, cochlear implants.	
	Audio adjustment	Mono audio	Disable / Enable Mono audio.
		Audio balance	Adjust the balance between left and right audio channels on sound devices.
	Accessibility shortcuts	Accessibility button	Quickly access accessibility features. Location / Size / Fade when not in use / Transparency when not in use
Shortcut from lock screen		Disable / Enable shortcut to access features from the lock screen.	
Text-to-speech output	Set the preferred engine, language, speech rate and pitch.		
Security & Privacy	Permission manager	Set app permissions.	
	Privacy dashboard	Review privacy settings and manage privacy preferences.	
	Ads	Manage ads personalization. Reset advertising ID, Opt out of Ads Personalization, Ads by Google	
	Health connect	Manage app access to health data.	
	Date sharing updates for location	Review apps that changed the way they may share your location data.	
	Camera access	For apps and services.	
	Microphone access	For apps and services. if this setting is off, microphone data may still be shared when you call an emergency.	
	Show clipboard access	Disable / Enable showing a message when apps access text, images, or other content you have copied.	
	Show passwords	Disable / Enable display password feature.	

[⌵ Settings]

Adjustment Item	Problem / Option		
Security & Privacy	Location access	For apps and services.	
	Activity controls	Choose the activities and info you allow Google to save.	
	More security & privacy	Autofill, Smart Lock, Device admin apps, Encryption & credentials, Trust agents, App pinning and more.	
Location	Use location	Disable / Enable location services.	
	App location permissions	Set App location permissions.	
	Location services	Earthquake alerts, Emergency Location Service, Google Location Sharing, Wi-Fi scanning, Bluetooth scanning	
Safety & emergency	Emergency information	Set personal medical information for preventing emergencies. Name, Blood type, Allergies, Medications, Address, Medical notes, Organ donor	
	Emergency SOS	Set up Emergency SOS to quickly initiate an emergency call or signal for help.	
	Emergency Location Service	Disable / Enable the emergency services to access location from the device.	
	Earthquake alerts	Disable / Enable receiving notifications about earthquakes.	
	Unknown tracker alerts	Disable / Enable notification if an unknown tracker is detected traveling with you.	
	Wireless emergency alerts		Disable / Enable to receive critical emergency alerts.
		Extreme threats	Receive the emergency alerts for extreme threats and severe threats.
		Severe threats	
		AMBER alerts	Receive the emergency alerts for missing children.
		Test alerts	Receive carrier tests and monthly tests from the safety alert system.
Emergency alert history		Display a log or record of previously received emergency alerts.	
Alert reminder	Set the reminders for emergency alerts. (Once / Every 2 minutes / Every 15 minutes / Never)		
Passwords & accounts	Set accounts and passwords.		
	Automatically sync app data	Disable / Enable automatic synchronization of app data.	
Digital Wellbeing & parental controls	Display a daily summary of your device usage and app activity frequency.		
	App limits	Set time limits for apps.	
	Bedtime mode	Customize the settings of Bedtime mode and Focus mode.	
	Focus mode		
	Manage notifications	Customize notifications and control interruptions.	

[ Settings]

Adjustment Item	Problem / Option		
Digital Wellbeing & parental controls	Do not Disturb	Customize notifications and control interruptions.	
	Heads Up		
	Show icon in the app list	Add content restrictions and set other limits to help your child balance their screen time.	
	Parental controls		
Google	Access settings related to Google services. Ads, Autofill, Backup, Devices & sharing, Find My Device, Parental controls, Personalize using shared data, Set up & restore, Settings for Google apps		
System	Languages	Set display language, keyboard and input method.	
	Keyboard	Language: Català / Čeština / Dansk / Deutsch / Eesti / English / Español / Français / Italiano / Latviešu / Lietuvių / Magyar / Nederlands / Norsk Bokmål / Polski / Suomi / Svenska / Русский / Українська	
	Gestures	Navigation mode	Set how you navigate the system. (Gesture navigation / 3-button navigation / Traditional navigation)
		Press and hold power button	Disable / Enable the feature to activate the assistant.
	Date & time	Set the Date and Time. Date, Time, Use location to set time zone, Time zone, Use locale default, Use 24-hour format, Date Format	
	Backup	Back up the data with Google one.	
	System update	Check and update to latest FirmWare version.	
	Reset options	Reset Wi-Fi, mobile & Bluetooth, Reset app preferences, Erase all data (factory reset)	
About device	Main info in About: Legal Information / Model / Serial number / Android Version / iiWare Version / IP address / Wi-Fi MAC address / Device Wi-Fi MAC address / Bluetooth address / Up time / Build number Automatically search update .zip from USB or SD card. When you select the updated .zip file, the monitor will restart and the update will start.		
Advanced settings	Auto Power on	Disable / Enable the Auto Power on/off function.	
	Auto Power off		
	No signal to Android	Enable the No signal signal to Android function.	
	No signal standby Timeout	After 5 minutes without video signal.	
	No signal screenoff Timeout	Disable / Enable the No signal screenoff Timeout function.	
	USB permissions	Only effective on Android.	

*1 WiFi will be turned off when the Ethernet is turned on.

*2 WiFi, Hotspot and Bluetooth can only be used when Option WiFi Module or Slot-PC is installed.

*3 WiFi will be turned off when the Ethernet is turned on.

④ Navigation toolbar appears

The navigation toolbar can be displayed on either left side or right side of the screen.

 : Back

 : Home

 : Back Stage

Clean all : Remove all in-progress apps

- Application -

You can customize up to 7 apps from "All Apps" to the navigation bar. (Drag and drop the app icon)

 : Whiteboard

 : File Manager

 : Browser

 : All Apps (Clean, Browser, Browser, iiyama Account, Cloud Drive, EShare Pro, Finder, iiyama Class, iiyama DMS, iiyama Share, iMirror, Keeper, Note, Palette, Settings, Viualizer, WPS Office)

- Sidebar -

Various operations can be quickly performed through the sidebar. How to open: click the translucent bar buttons on the left and right sides to expand the sidebar, and click the blank area to close the sidebar. Sidebar functions include: Back, Home, Multitasking, Annotation, Signal Source, Control Panel, Device Menu.

 : Annotation

 : Signal source

 : Control panel

Top: You can operate Wi-Fi, hotspot and Bluetooth functions quickly, and click the bottom right corner to enter the relevant page in the settings.

Middle: you can turn on or off several shortcut tools.

 : Ethernet network: Tap on/off the wired network.

 : Screenshot: Click to open the screenshot tool, when open, the sidebar will automatically hide.

 : Smart eye protection: Click on/off to reduce the blue light of the screen after opening to reduce the damage to the eyes.

 : Auto backlight: click on open/close, after opening, the screen brightness drops by 30% when touching, and the brightness recovers after 5s without touch to reduce the brightness glare during operation or writing.

 : ECO: Click open/close, after opening, the screen brightness is set to 25, and turn off the automatic adjustment of brightness, if you manually adjust the brightness or open the automatic adjustment, the energy-saving mode will automatically turn off.

 : Touch lock: After opening, the touch of the screen is locked, and the touch event does not respond. The lock logo is displayed at the top left of the interface, and the method of removing the lock is as follows:

(1) Using the remote control key combination, press V-,V-,V+,V+ in succession

(2) Use files

a. Create a new text document

b. Input U2FsdGVkX18v36IH2OloQYdlbG + Y18YkDs9R1ACvSE =

c. Name the file usb_child_key

- d. Remove the file extension.txt
- e. The file characters are UTF-8
- f. After saving and in the U disk root directory
- g. Insert the USB key in touch lock mode to unlock

 : Screen lock: Click the lock screen, you can modify the lock screen unlock mode in System Settings.

 : Sound only: Click and the screen goes off, only the sound output is retained.

 : Backlight off: Screen goes off when clicked (Double-click with two fingers on the screen to trigger on or off.)

 : Turn off OPS: Click to switch off OPS.

 : Power off: Click to switch off the machine.

 : Restart: Click to reboot the machine.

 : Freeze: Click on the screen to be fixed.

 : Screen down: Click to move the screen down by one-third (Pull down by three fingers on the top of the screen to trigger on or off.)

 : Spotlight: Click to open the spotlight.

Bottom: Show all the application functions, tap once to open the corresponding application, long press the application with "multi-window icon", you can open the application in the form of a free window.

 : Device Menu: Refer to page 25 for detailed operation.

 : AI Screen Recognition

Through AI screen recognition, it meets the user's need to search for any element within any scene or interface. The figure below is an example of a browser application:

1. When we are browsing a certain type of information, if we want to further search for images or text in it, we can click on the sidebar, and then click on the AI screen recognition button at the bottom . At this time to enter the circle selection mode, you can click on the lower left corner to view the operating instructions.

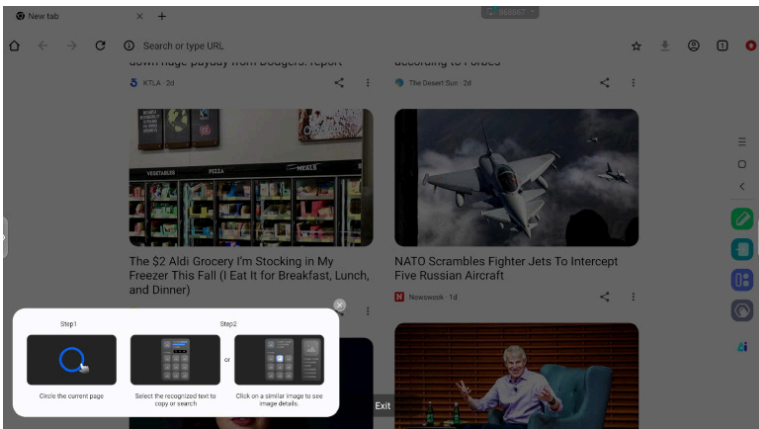

2. Circle the content you want to search, after lifting your hand, the content through the AI screen function, extract the relevant text and images displayed in the pop-up window.

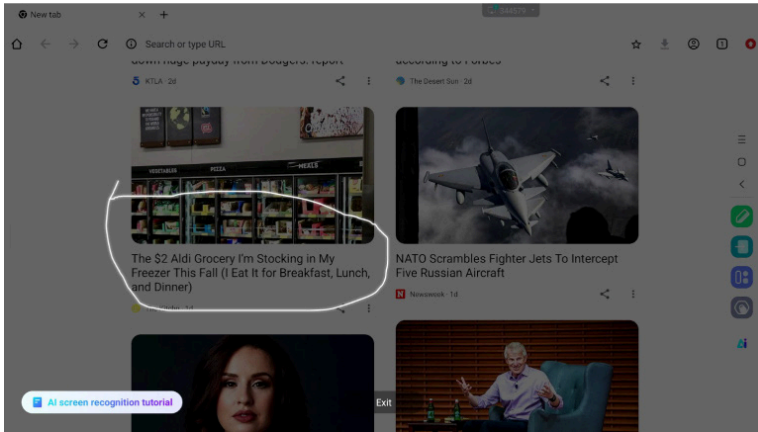

3. You can select a text and then search or copy the text in the browser, or click on the picture and then view the picture details in the browser on the right.

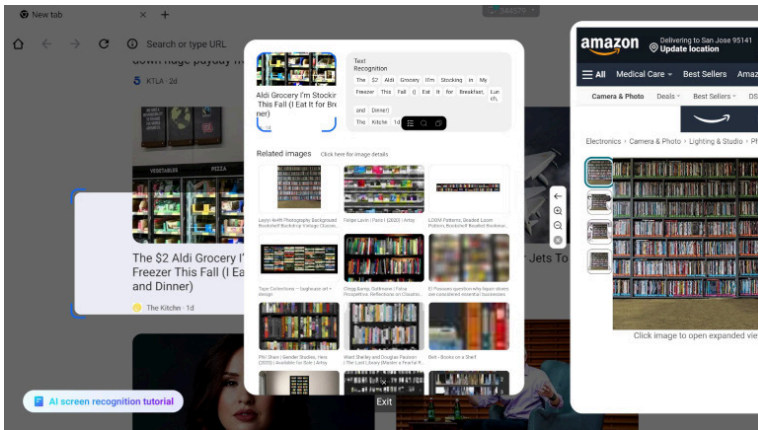

④Radial Menu

The radial menu provides the user with a quick way to operate, and the user can open the application in the form of a free window through the radial menu, the basic operation is as follows:

- Long press with five fingers in any interface to bring up the radial menu.
- Tap the circle in the middle to expand or retract the radial menu.
- Drag the circle in the middle to move the position of the radial menu.

: Radial Menu Folded State

it is a colourful floating ball, which can be covered on the top of the application page, and can be dragged and placed anywhere on the page.

Radial Menu Expanded State: Radial menu supports 6 functions in total, the system default configuration is Back, Home, Browser, File Manager and Multitasking (all can be customised, Swipe left for widgets.), tap "plus" or long-press any application to enter the Edit Mode, the application menu will appear. Users can directly select the frequently used applications in the application menu and place them in the radial menu.

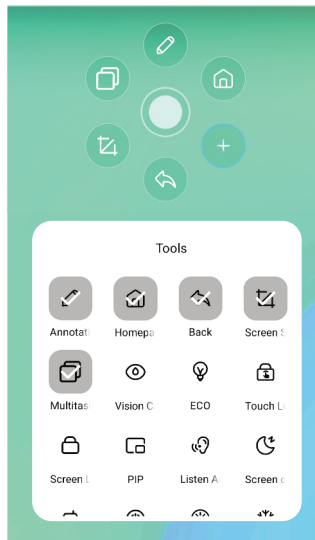

④ Shortcut*

- App -

Drag and drop the App icon from "All apps" to create a shortcut icon on the screen.

- File / Folder -

Drag and drop a File or Folder from the Finder to create a shortcut icon on the screen.

- Website -

Create a shortcut by opening the desired website and clicking "Send the quick-link to Desktop" in the settings menu.

- Move -

Move by long-pressing the icon and dragging and dropping.

- Remove -

Remove it by long-pressing the icon and clicking Remove from the menu.

* Available after login in iiyama account.

<How to use Votekit>

- ① Tap the  app icon to access the app.
- ② The voting theme and option Settings page is displayed, and click the input box to call the keyboard input.
- ③ Click "Reset" to clear the options and themes; Click Next to set single/multiple select, anonymous/real name requirements
- ④ Click "Start voting" to display the QR code of voting. Participants can vote by scanning the code, and the voting results are refresher in real time
- ⑤ Click "End voting" to finish the voting, the QR code fills the function, and the voting page is closed; The voting statistics results are presented.
- ⑥ Click "Save" to save the voting results; Click "Insert whiteboard" to insert the voting results into the whiteboard for display.

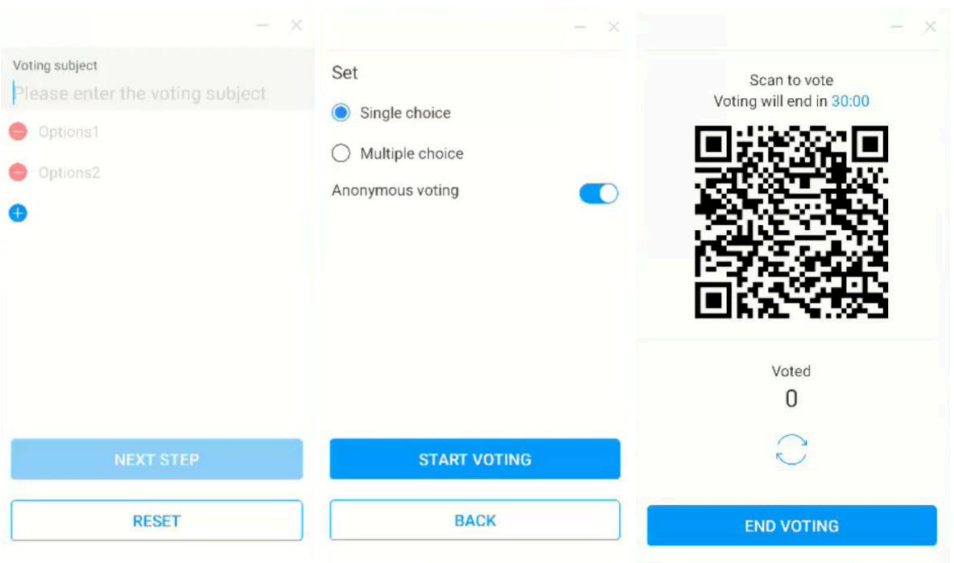

[Whiteboard]

This is a writing software.

Can write the characters, Lines and pictures like a whiteboard. Also, can insert an image or file.

Click  with the touch pen.

- Tools -

Menu: Display menu of Whiteboard.

New: Save the Whiteboard writing and open a new Note.

Open: Open the file.

Save: Save the current document to image format to file browser.

Save as: Store a file in addition to the current file.

Upload To Cloud: Upload the whiteboard file to the network disk for saving, and you can choose different formats, such as: source,image and pdf files.

QR code: click to present and share the two-dimensional code, and users can download the whiteboard picture file by scanning the code. Click the encryption above the QR code to generate a digital password. After scanning the code, you need to enter the password to obtain the content Support local area network and external network sharing two ways, users can choose the default mode in the system Settings.

Email: After binding the mailbox, the whiteboard file can be sent directly through the mailbox.

Settings: The general Settings of the whiteboard are used to set the various states of the whiteboard according to the requirements.

Exit: Return to main screen.

Pen: Change the width and color of the stroke. (Pen/Handwriting size/Handwriting color)

Eraser: Erase the specified object.

Select: Select the object being edit, can move, can zoom.

Shape: Draw the shape.

Toolbox: A variety of tools can be inserted into the whiteboard, including images, tables, math tools, signal source, mind maps, documents, videos, browsers, votekit, timer, easy upload, camera, four line grid, site, sticky notes.

Undo: Cancel

Redo : Redo

Aerial View: The Aerial View allows you to see exactly where the current view is located within the whiteboard, and the view can be moved directly by pressing and holding the blue frame within the Aerial View or by directly clicking on different areas of the Aerial View. Click [Back to] to adjust the view to the view before entering the Aerial View.

- Extension function of the pen -

After selecting the handwriting, the handwriting can be turn to intelligent text and for further processing.

Tools : Color, Smartwrite, Search, Flip, Top, Clone, Delete

- Image expansion function -

After selecting the image, the image can be transformed into vector image, and the image can be mirrored.

Tools : Crop, SVG, Flip, Top, Move to, Clone, Delete

[File Manager]

Click  with the touch pen.

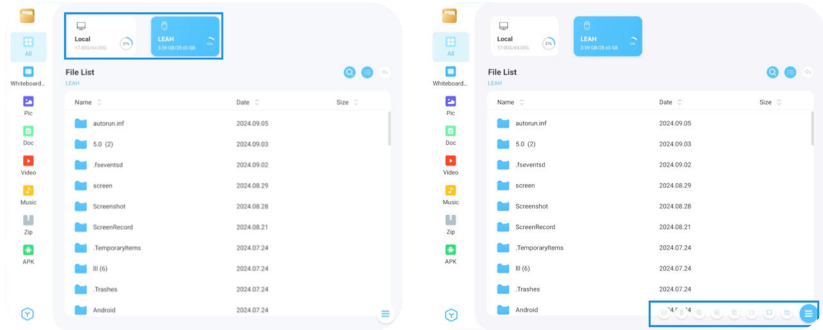

The File Manager allows you to view files on the system locally and on external devices, providing two forms of viewing:

⌘ All Files: Open by folder directory

⌘ Category View: Find all kinds of files locally and in the USB stick by file type, such as whiteboard files, pictures, documents, videos, music, zip packages and APKs.

Browse the files stored in the internal storage device, the USB storage, Public Cloud, Remote File and your Cloud storage.

⌘ Supported Format

DOC : PPT, Word, Excel, PDF (Open the file by using the WPS Office)

Note : Note files, screenshot

Movie : .3g2 .3gp .avi .flv .f4v .mkv .mov .mp4 .VOB.mpg/.MPEG .ts

Picture : .jpg .jpeg .png .bmp .gif

Music : .aac .ape .flac .m4a .mp3 .ogg .wav

- Tools -

 : Search

 : Cancel

 : Grid

 : List

 : Back

 : Exit

 : Delete

 : Paste

 : Cut

 : Copy

 : Rename

 : Select All

 : Create folder

 : Function list

 : Switch to Cloud Drive and Telefile page

 : Cloud Drive: Add OneDrive or Google Drive to the File Manager

 : Remote file: Support access to SAMBA(SM3.0) and FTP server

My Files

"My files" folder will be created in your OneDrive or Google Drive once connected to your iiyama account.

Remote File

Support access to SAMBA(SMB1.0) and FTP server.

[Browser (Web Browser)]

Connect the network, and browse the web.

Click  with the touch pen.

[Google Drive]

Connect the network, and the Cloud Drive.

Click  with the touch pen.

[EShare Pro]

EShare is a multiscreen interaction application which makes the user experience natural and enjoyable for home entertainment, business presentation, and educational training.

Click  with the touch pen.

[iiControl]

This software provides organizations with a convenient and fast unified management solution for terminal equipment, builds an efficient and real-time equipment management system, helps digitize the campus environment and makes campus management more convenient.

Click  with the touch pen.

[iiShare]

This is the software that can wirelessly share the screen with other notebook etc..

Click  with the touch pen.

[Camera]

You can select the camera to use from the camera device connected to the machine and display a preview of the camera.

Click  with the touch pen.

STANDBY FEATURE

④ Standby Mode

When the video signal from the computer is off, the monitor enters into Standby Mode which reduces the power consumption to less than 0.5W. The screen becomes dark, and the power indicator turns to red. From Standby Mode, the image reappears in several seconds when either the keyboard or the mouse are touched again.

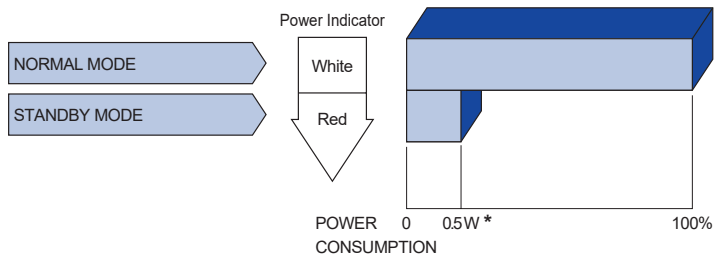

* When the USB devices are not connected.

TROUBLE SHOOTING

If the monitor fails to operate correctly, please follow the steps below for a possible solution.

1. Perform the adjustments described in OPERATING THE MONITOR, depending on the problem you have. If the monitor does not get a picture, skip to 2.
2. Consult the following items if you cannot find an appropriate adjustment item in OPERATING THE MONITOR or if the problem persists.
3. If you are experiencing a problem which is not described below or you cannot correct the problem, discontinue using the monitor and contact your dealer or iiyama service center for further assistance.

Problem	Check
① The picture does not appear. (Power indicator does not light up.) (Power indicator is white.) (Power indicator is red.)	<ul style="list-style-type: none"> ⑤ The Power Cable is firmly seated in the socket. ⑤ The Power Switch is turned ON. ⑤ The AC socket is live. Please check with another piece of equipment. ⑤ If the blank screen saver is in active mode, touch the keyboard or the mouse. ⑤ Increase the Contrast and/or Brightness. ⑤ The computer is ON. ⑤ The Signal Cable is properly connected. ⑤ The signal timing of the computer is within the specification of the display. ⑤ If the monitor show "No Signal", touch the keyboard or the mouse. ⑤ The computer is ON. ⑤ The Signal Cable is properly connected. ⑤ The signal timing of the computer is within the specification of the display.
② The screen is not synchronized.	<ul style="list-style-type: none"> ⑤ The Signal Cable is properly connected. ⑤ The signal timing of the computer is within the specification of the monitor.
③ The screen position is not in the center.	<ul style="list-style-type: none"> ⑤ The signal timing of the computer is within the specification of the monitor.
④ The screen is too bright or too dark.	<ul style="list-style-type: none"> ⑤ The video output level of the computer is within the specification of the monitor.
⑤ The screen is shaking.	<ul style="list-style-type: none"> ⑤ The power voltage is within the specification of the monitor. ⑤ The signal timing of the computer is within the specification of the monitor.
⑥ No sound.	<ul style="list-style-type: none"> ⑤ The audio equipment (computer etc.) is ON. ⑤ The Audio Cable is properly connected. ⑤ The Volume is turned up. ⑤ The Mute is OFF. ⑤ The audio output level of the audio equipment is within the specification of the monitor.
⑦ The sound is too loud or too quiet.	<ul style="list-style-type: none"> ⑤ The audio output level of the audio equipment is within the specification of the monitor.
⑧ A strange noise is heard.	<ul style="list-style-type: none"> ⑤ The Audio Cable is properly connected.

Problem

- ⑨ The touch screen shows no response.
- ⑩ The touch position does not deviate.

Check

- ⑤ The USB Cable is firmly seated in the socket.
- ⑤ Touch screen driver software is installed.
- ⑤ The calibration function set up correctly.

RECYCLING INFORMATION

For better environment protection please don't dispose your monitor.
Please visit our web site: <https://iiyama.com> for monitor recycling.

APPENDIX

Design and specifications are subject to change without prior notice.

SPECIFICATIONS : ProLite TE9813A-B1AG

Touch Screen	Technology	IR Touch 40points
	Light transmission	88%
	Hardness	7H
	Thickness	4mm
	Communication system	USB serial transfer
	Response time	8ms
Size Category		98"
LCD Panel	Panel technology	IPS
	Size	Diagonal: 97.5" (247.70cm)
	Pixel pitch	0.5622mm H × 0.5622mm V
	Brightness	450cd/m ² (Typical, panel), 230cd/m ² (Default / Energy Saving)
	Contrast ratio	1200 : 1 (Typical: without glass)
	Viewable angle	Horizontal : 178 degrees, Vertical: 178 degrees (Typical)
	Response time	8ms (Typical, Gray to Gray)
Display Colors		Approx. 1.07B
Sync Frequency		HDMI1/2: Horizontal: 30.0-135.0kHz, Vertical: 24-60Hz DisplayPort / USB-C 3.2 Gen1: Horizontal: 30.0-135.0kHz, Vertical: 24-60Hz
Native Resolution		3840 × 2160, 8.3 MegaPixels
Supported max. resolution		HDMI1/2: 3840 × 2160 60Hz (YUV420/RGB444/YUV444) DisplayPort / USB-C 3.2Gen1: 3840 × 2160 60Hz
Input Connector		HDMI ×2, DisplayPort ×1, USB-C ×2
USB Standard		USB2.0 (DC5V, 500mA) ×1 USB3.2 Gen 1 (5Gbps, DC5V, 900mA) ×3 (Front: 2, Side: 1) USB-C 2.0 480Mbps, (5V, 3A / 9V, 3A / 12V, 3A / 20V, 5A) ×1 *1 USB-C 3.2 Gen1 (5Gbps, 5V, 3A) ×1 *1
Number of USB Ports Connector shape		2 : Type C 1 Upstream : Type B (for touch) 4 Downstream : Type A
MIC IN Connector		ø 3.5mm mini jack (Stereo)
Audio Out Connector *2		ø 3.5mm mini jack (Stereo)
LAN		RJ45 ×2 (in/out)
Serial Port		RS-232C In
Input Video Signal		Digital: HDMI, DisplayPort, USB-C 3.2 Gen1 (DisplayPort 1.2)
Input Audio Signal		2.0Vrms maximum
Output Connector		HDMI 3840 × 2160 60Hz
SPDIF out Connector		SPDIF

Speakers	Internal: 2 Typical: 20W (Stereo speakers) 1 Typical: 20W Subwoofer
NFC Reader	Support ISO/IEC 14443 A, ISO/IEC 14443 B, ISO/IEC 15693, MIFARE 1K / 4K, MIFARE DESFire, Sony FeliCa (According to ISO/IEC 18092 (Ecma 340) standard.)
PIR	Detection Angle: 120° Detection Range: Up to 6 meters
iiWare Version	V21E (Powered by Android™ 14)
Maximum Screen Size	2158.848mm W × 1214.352mm H / 85.0" W × 47.8" H
Power Source	100-240VAC, 50/60Hz, 9A
Power Consumption *3	303W typical (Default / Energy Saving) Standby Mode: 0.5W maximum, Off mode: 0.3W maximum
Dimensions / Net Weight	2235.5 × 1326.0 × 136.5mm / 88.0 × 52.2 × 5.4" (W×H×D) 98.5kg / 217.2lbs
Environmental Considerations	Operating: Temperature 0 to 40°C / 32 to 104°F Humidity 10 to 90% (No condensation) Storage: Temperature -20 to 60°C / 4 to 140°F Humidity 10 to 90% (No condensation)
Approvals	CE, UKCA, TÜV-GS, EAC

NOTE *1 DisplayPort 1.2 ALT mode/Touch/Power Delivery, it needs a full-function type C-C cable with EMARK certification.

*2 It is not supported to use a headset with this port.

*3 When the USB devices are not connected.

SPECIFICATIONS : ProLite TE8613A-B1AG

Touch Screen	Technology	IR Touch 40points
	Light transmission	88%
	Hardness	7H
	Thickness	3.2mm
	Communication system	USB serial transfer
	Response time	8ms
Size Category		86"
LCD Panel	Panel technology	IPS
	Size	Diagonal: 85.6" (217.4cm)
	Pixel pitch	0.4935mm H × 0.4935mm V
	Brightness	500cd/m ² (Typical, panel), 285cd/m ² (Default / Energy Saving)
	Contrast ratio	1200 : 1 (Typical: without glass)
	Viewable angle	Horizontal : 178 degrees, Vertical: 178 degrees (Typical)
	Response time	8ms (Typical, Gray to Gray)
Display Colors		Approx.1.07B
Sync Frequency		HDMI1/2: Horizontal: 30.0-135.0kHz, Vertical: 24-60Hz DisplayPort / USB-C 3.2 Gen1: Horizontal: 30.0-135.0kHz, Vertical: 24-60Hz
Native Resolution		3840 × 2160, 8.3 MegaPixels
Supported max. resolution		HDMI1/2: 3840 × 2160 60Hz (YUV420/RGB444/YUV444) DisplayPort / USB-C 3.2 Gen1: 3840 × 2160 60Hz
Input Connector		HDMI ×2, DisplayPort ×1, USB-C ×2
USB Standard		USB2.0 (DC5V, 500mA) ×1 USB3.2 Gen 1 (5Gbps, DC5V, 900mA) ×3 (Front: 2, Side: 1) USB-C 2.0 480Mbps, (5V, 3A / 9V, 3A / 12V, 3A / 20V, 3.25A) ×1 *1 USB-C 3.2 Gen1 (5Gbps, 5V, 3A / 9V, 3A / 12V, 3A / 20V, 5A) ×1 *1
Number of USB Ports Connector shape		2 : Type C 1 Upstream : Type B (for touch) 4 Downstream : Type A
MIC IN Connector		ø 3.5mm mini jack (Stereo)
Audio Out Connector *2		ø 3.5mm mini jack (Stereo)
LAN		RJ45 ×2 (in/out)
Serial Port		RS-232C In
Input Video Signal		Digital: HDMI, DisplayPort, USB-C 3.2 Gen1 (DisplayPort 1.2)
Input Audio Signal		2.0Vrms maximum
Output Connector		HDMI 3840 × 2160 60Hz
SPDIF out Connector		SPDIF

Speakers	Internal: 2 Typical: 20W (Stereo speakers) 1 Typical: 20W Subwoofer
NFC Reader	Support ISO/IEC 14443 A, ISO/IEC 14443 B, ISO/IEC 15693, MIFARE 1K / 4K, MIFARE DESFire, Sony FeliCa (According to ISO/IEC 18092 (Ecma 340) standard.)
PIR	Detection Angle: 120° Detection Range: Up to 6 meters
iiWare Version	V21E (Powered by Android™ 14)
Maximum Screen Size	1895.0mm W × 1066.0mm H / 74.6" W × 42.0" H
Power Source	100-240VAC, 50/60Hz, 6A
Power Consumption * ³	282W typical (Default / Energy Saving) Standby Mode: 0.5W maximum, Off mode: 0.3W maximum
Dimensions / Net Weight	1955.5 × 1154.0 × 120.5mm / 77.0 × 45.4 × 4.7" (W×H×D) 58.6kg / 129.2lbs
Environmental Considerations	Operating: Temperature 0 to 40°C / 32 to 104°F Humidity 10 to 90% (No condensation) Storage: Temperature -20 to 60°C / 4 to 140°F Humidity 10 to 90% (No condensation)
Approvals	CE, UKCA, TÜV-GS, EAC

NOTE *¹ DisplayPort 1.2 ALT mode/Touch/Power Delivery when the OPS is running, USB-C 3.2 it only supports 65W, USB-C 2.0 it only supports 15W.

It needs a full-function type C-C cable with EMARK certification.

*² It is not supported to use a headset with this port.

*³ When the USB devices are not connected.

SPECIFICATIONS : ProLite TE7513A-B1AG

Touch Screen	Technology	IR Touch 40points
	Light transmission	88%
	Hardness	7H
	Thickness	3.2mm
	Communication system	USB serial transfer
	Response time	8ms
Size Category		75"
LCD Panel	Panel technology	IPS
	Size	Diagonal: 74.52" (189.273cm)
	Pixel pitch	0.4296mm H × 0.4296mm V
	Brightness	500cd/m ² (Typical, panel), 285cd/m ² (Default / Energy Saving)
	Contrast ratio	1200 : 1 (Typical: without glass)
	Viewable angle	Horizontal : 178 degrees, Vertical: 178 degrees (Typical)
	Response time	8ms (Typical, Gray to Gray)
Display Colors		Approx.1.07B
Sync Frequency		HDMI1/2: Horizontal: 30.0-135.0kHz, Vertical: 24-60Hz DisplayPort / USB-C 3.2 Gen1: Horizontal: 30.0-135.0kHz, Vertical: 24-60Hz
Native Resolution		3840 × 2160, 8.3 MegaPixels
Supported max. resolution		HDMI1/2: 3840 × 2160 60Hz (YUV420/RGB444/YUV444) DisplayPort / USB-C 3.2 Gen1: 3840 × 2160 60Hz
Input Connector		HDMI ×2, DisplayPort ×1, USB-C ×2
USB Standard		USB2.0 (DC5V, 500mA) ×1 USB3.2 Gen 1 (5Gbps, DC5V, 900mA) ×3 (Front: 2, Side: 1) USB-C 2.0 480Mbps, (5V, 3A / 9V, 3A / 12V, 3A / 20V, 3.25A) ×1 *1 USB-C 3.2 Gen1 (5Gbps, 5V, 3A / 9V, 3A / 12V, 3A / 20V, 5A) ×1 *1
Number of USB Ports Connector shape		2 : Type C 1 Upstream : Type B (for touch) 4 Downstream : Type A
MIC IN Connector		ø 3.5mm mini jack (Stereo)
Audio Out Connector *2		ø 3.5mm mini jack (Stereo)
LAN		RJ45 ×2 (in/out)
Serial Port		RS-232C In
Input Video Signal		Digital: HDMI, DisplayPort, USB-C 3.2 Gen1 (DisplayPort 1.2)
Input Audio Signal		2.0Vrms maximum
Output Connector		HDMI 3840 × 2160 60Hz
SPDIF out Connector		SPDIF

Speakers	Internal: 2 Typical: 20W (Stereo speakers) 1 Typical: 20W Subwoofer
NFC Reader	Support ISO/IEC 14443 A, ISO/IEC 14443 B, ISO/IEC 15693, MIFARE 1K / 4K, MIFARE DESFire, Sony FeliCa (According to ISO/IEC 18092 (Ecma 340) standard.)
PIR	Detection Angle: 120° Detection Range: Up to 6 meters
iiWare Version	V21E (Powered by Android™ 14)
Maximum Screen Size	1650.0mm W × 928.0mm H / 65.0" W × 36.5" H
Power Source	100-240VAC, 50/60Hz, 5.5A
Power Consumption * ³	217W typical (Default / Energy Saving) Standby Mode: 0.5W maximum, Off mode: 0.3W maximum
Dimensions / Net Weight	1710.0 × 1016.0 × 120.5mm / 67.3 × 40.0 × 4.7" (W×H×D) 47.3kg / 104.3lbs
Environmental Considerations	Operating: Temperature 0 to 40°C / 32 to 104°F Humidity 10 to 90% (No condensation) Storage: Temperature -20 to 60°C / 4 to 140°F Humidity 10 to 90% (No condensation)
Approvals	CE, UKCA, TÜV-GS, EAC

NOTE *¹ DisplayPort 1.2 ALT mode/Touch/Power Delivery when the OPS is running, USB-C 3.2 it only supports 65W, USB-C 2.0 it only supports 15W.

It needs a full-function type C-C cable with EMARK certification.

*² It is not supported to use a headset with this port.

*³ When the USB devices are not connected.

SPECIFICATIONS : ProLite TE6513A-B1AG

Touch Screen	Technology	IR Touch 40points
	Light transmission	88%
	Hardness	7H
	Thickness	3.2mm
	Communication system	USB serial transfer
	Response time	8ms
Size Category		65"
LCD Panel	Panel technology	IPS
	Size	Diagonal: 64.5" (163.9cm)
	Pixel pitch	0.372mm H × 0.372mm V
	Brightness	500cd/m ² (Typical, panel), 285cd/m ² (Default / Energy Saving)
	Contrast ratio	1200 : 1 (Typical: without glass)
	Viewable angle	Horizontal : 178 degrees, Vertical: 178 degrees (Typical)
	Response time	8ms (Typical, Gray to Gray)
Display Colors		Approx.1.07B
Sync Frequency		HDMI1/2: Horizontal: 30.0-135.0kHz, Vertical: 24-60Hz DisplayPort / USB-C 3.2 Gen1: Horizontal: 30.0-135.0kHz, Vertical: 24-60Hz
Native Resolution		3840 × 2160, 8.3 MegaPixels
Supported max. resolution		HDMI1/2: 3840 × 2160 60Hz (YUV420/RGB444/YUV444) DisplayPort / USB-C 3.2 Gen1: 3840 × 2160 60Hz
Input Connector		HDMI ×2, DisplayPort ×1, USB-C ×2
USB Standard		USB2.0 (DC5V, 500mA) ×1 USB3.2 Gen 1 (5Gbps, DC5V, 900mA) ×3 (Front: 2, Side: 1) USB-C 2.0 480Mbps, (5V, 3A / 9V, 3A / 12V, 3A / 20V, 3.25A) ×1 *1 USB-C 3.2 Gen1 (5Gbps, 5V, 3A / 9V, 3A / 12V, 3A / 20V, 5A) ×1 *1
Number of USB Ports Connector shape		2 : Type C 1 Upstream : Type B (for touch) 4 Downstream : Type A
MIC IN Connector		ø 3.5mm mini jack (Stereo)
Audio Out Connector *2		ø 3.5mm mini jack (Stereo)
LAN		RJ45 ×2 (in/out)
Serial Port		RS-232C In
Input Video Signal		Digital: HDMI, DisplayPort, USB-C 3.2 Gen1 (DisplayPort 1.2)
Input Audio Signal		2.0Vrms maximum
Output Connector		HDMI 3840 × 2160 60Hz
SPDIF out Connector		SPDIF

Speakers	Internal: 2 Typical: 20W (Stereo speakers) 1 Typical: 20W Subwoofer
NFC Reader	Support ISO/IEC 14443 A, ISO/IEC 14443 B, ISO/IEC 15693, MIFARE 1K / 4K, MIFARE DESFire, Sony FeliCa (According to ISO/IEC 18092 (Ecma 340) standard.)
PIR	Detection Angle: 120° Detection Range: Up to 6 meters
iiWare Version	V21E (Powered by Android™ 14)
Maximum Screen Size	1428.5mm W × 803.5mm H / 56.2" W × 31.6" H
Power Source	100-240VAC, 50/60Hz, 5.5A
Power Consumption * ³	182W typical (Default / Energy Saving) Standby Mode: 0.5W maximum, Off mode: 0.3W maximum
Dimensions / Net Weight	1489.0 × 891.5 × 118.5mm / 58.6 × 35.1 × 4.6" (W×H×D) 35.0kg / 77.2lbs
Environmental Considerations	Operating: Temperature 0 to 40°C / 32 to 104°F Humidity 10 to 90% (No condensation) Storage: Temperature -20 to 60°C / 4 to 140°F Humidity 10 to 90% (No condensation)
Approvals	CE, UKCA, TÜV-GS, EAC

NOTE

*¹ DisplayPort 1.2 ALT mode/Touch/Power Delivery when the OPS is running, USB-C 3.2 it only supports 65W, USB-C 2.0 it only supports 15W.

It needs a full-function type C-C cable with EMARK certification.

*² It is not supported to use a headset with this port.

*³ When the USB devices are not connected.

SPECIFICATIONS : ProLite TE5513A-B1AG

Touch Screen	Technology	IR Touch 40points
	Light transmission	88%
	Hardness	7H
	Thickness	3.2mm
	Communication system	USB serial transfer
	Response time	8ms
Size Category		55"
LCD Panel	Panel technology	IPS
	Size	Diagonal: 54.6" (138.8cm)
	Pixel pitch	0.315mm H × 0.315mm V
	Brightness	450cd/m ² (Typical, panel), 255cd/m ² (Default / Energy Saving)
	Contrast ratio	1200 : 1 (Typical: without glass)
	Viewable angle	Horizontal : 178 degrees, Vertical: 178 degrees (Typical)
	Response time	8ms (Typical, Gray to Gray)
Display Colors		Approx.1.07B
Sync Frequency		HDMI1/2: Horizontal: 30.0-135.0kHz, Vertical: 24-60Hz DisplayPort / USB-C 3.2 Gen1: Horizontal: 30.0-135.0kHz, Vertical: 24-60Hz
Native Resolution		3840 × 2160, 8.3 MegaPixels
Supported max. resolution		HDMI1/2: 3840 × 2160 60Hz (YUV420/RGB444/YUV444) DisplayPort / USB-C 3.2 Gen1: 3840 × 2160 60Hz
Input Connector		HDMI ×2, DisplayPort ×1, USB-C ×2
USB Standard		USB2.0 (DC5V, 500mA) ×1 USB3.2 Gen 1 (5Gbps, DC5V, 900mA) ×3 (Front: 2, Side: 1) USB-C 2.0 480Mbps, (5V, 3A / 9V, 3A / 12V, 3A / 20V, 3.25A) ×1 *1 USB-C 3.2 Gen1 (5Gbps, 5V, 3A / 9V, 3A / 12V, 3A / 20V, 5A) ×1 *1
Number of USB Ports Connector shape		2 : Type C 1 Upstream : Type B (for touch) 4 Downstream : Type A
MIC IN Connector		ø 3.5mm mini jack (Stereo)
Audio Out Connector *2		ø 3.5mm mini jack (Stereo)
LAN		RJ45 ×2 (in/out)
Serial Port		RS-232C In
Input Video Signal		Digital: HDMI, DisplayPort, USB-C 3.2 Gen1 (DisplayPort 1.2)
Input Audio Signal		2.0Vrms maximum
Output Connector		HDMI 3840 × 2160 60Hz
SPDIF out Connector		SPDIF

Speakers	Internal: 2 Typical: 20W (Stereo speakers) 1 Typical: 20W Subwoofer
NFC Reader	Support ISO/IEC 14443 A, ISO/IEC 14443 B, ISO/IEC 15693, MIFARE 1K / 4K, MIFARE DESFire, Sony FeliCa (According to ISO/IEC 18092 (Ecma 340) standard.)
PIR	Detection Angle: 120° Detection Range: Up to 6 meters
iiWare Version	V21E (Powered by Android™ 14)
Maximum Screen Size	1209.6mm W × 680.4mm H / 47.6" W × 26.8" H
Power Source	100-240VAC, 50/60Hz, 5.5A
Power Consumption * ³	125W typical (Default / Energy Saving) Standby Mode: 0.5W maximum, Off mode: 0.3W maximum
Dimensions / Net Weight	1267.0 × 765.5 × 117.5mm / 49.9 × 30.1 × 4.6" (W×H×D) 26.1kg / 57.5lbs
Environmental Considerations	Operating: Temperature 0 to 40°C / 32 to 104°F Humidity 10 to 90% (No condensation) Storage: Temperature -20 to 60°C / 4 to 140°F Humidity 10 to 90% (No condensation)
Approvals	CE, UKCA, TÜV-GS, EAC

NOTE *¹ DisplayPort 1.2 ALT mode/Touch/Power Delivery when the OPS is running, USB-C 3.2 it only supports 65W, USB-C 2.0 it only supports 15W.

It needs a full-function type C-C cable with EMARK certification.

*² It is not supported to use a headset with this port.

*³ When the USB devices are not connected.

Android and Google Drive are trademarks of Google LLC.

DIMENSIONS : ProLite TE7513A

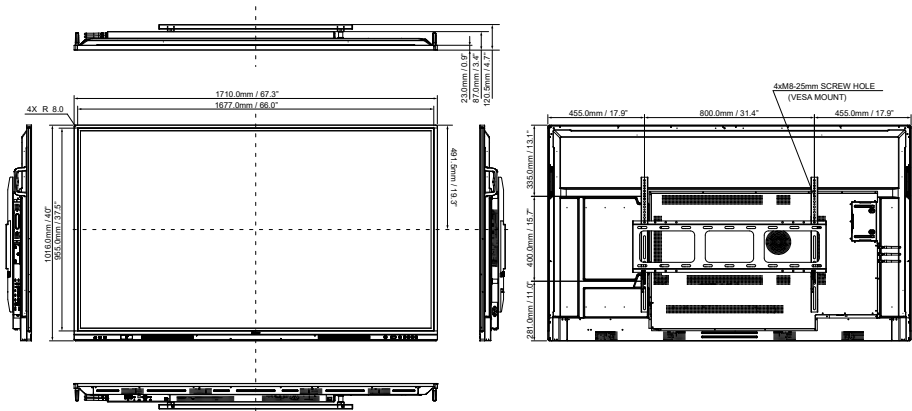

DIMENSIONS : ProLite TE6513A

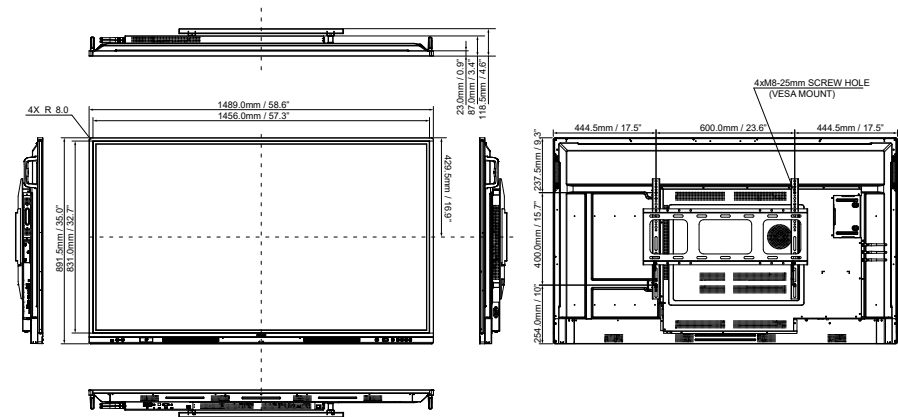

DIMENSIONS : ProLite TE5513A

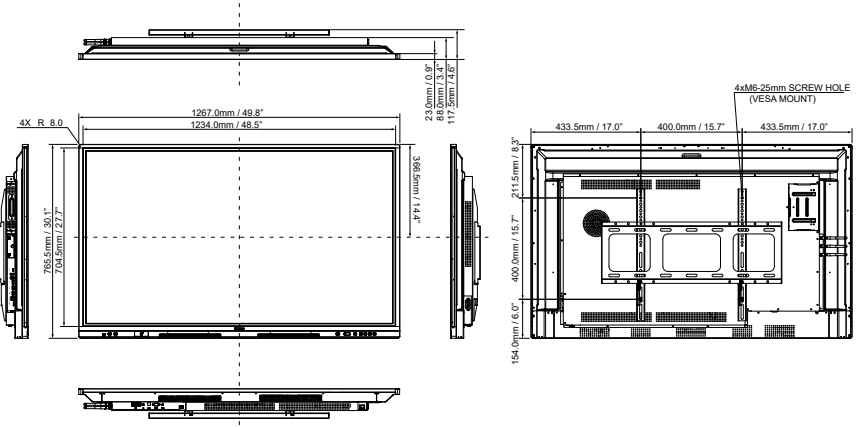

ENGLISH

COMPLIANT TIMING

Timing		fH(kHz)	fV(Hz)	Dot clock (MHz)	HDMI1	HDMI2	DisplayPort	USB-C (DisplayPort)
VESA	VGA 640x480	31.5	60.0	25.175	○	○	○	○
	SVGA 800x600	37.9	60.0	40.000	○	○	○	○
	XGA 1024x768	48.4	60.0	65.000	○	○	○	○
	WXGA 1280x768	47.8	60.0	79.500	○	○	○	○
	QVGA 1280x960	60.0	60.0	108.000	○	○	○	○
	SXGA 1280x1024	64.0	60.0	108.000	○	○	○	○
	HD FWXGA 1366x768	47.7	60.0	85.500	○	○	○	○
	CVT 1400x900	55.9	60.0	106.500	○	○	○	○
	WSXGA 1680x1050	65.3	60.0	146.250	○	○	○	○
	FHD 1920x1080	67.5	60.0	148.500	○	○	○	○
	4K 3840x2160	67.5	30.0	297.000	○	○	○	○
112.5		50.0	594.000	○	○	○	○	
135.0		60.0	594.000	○	○	○	○	
IBM	720x400	31.5	70.0	28.320	○	○	○	○
SD	NTSC-M	15.7	60.0	13.500				
	NTSC-J	15.7	60.0	13.500				
	PAL-BDGHI	15.7	60.0	13.500				
	480i 60Hz	15.7	60.0	13.500	○	○	○	○
	576i 50Hz	15.6	50.0	13.500	○	○	○	○
	480p 60Hz	31.5	60.0	27.000	○	○	○	○
	576p 50Hz	31.3	50.0	27.000	○	○	○	○
HD	720p	50Hz	37.5	50.0	74.250	○	○	○
		60Hz	45.0	60.0	74.250	○	○	○
	1080i	50Hz	28.1	50.0	74.250	○	○	○
		60Hz	33.8	60.0	74.250	○	○	○
	1080p	50Hz	56.3	50.0	148.500	○	○	○
		60Hz	67.5	60.0	148.500	○	○	○

* ○ means supported the timing.